

RESISTANCE HEATING ALLOYS FOR ELECTRIC APPLIANCES

HANDBOOK

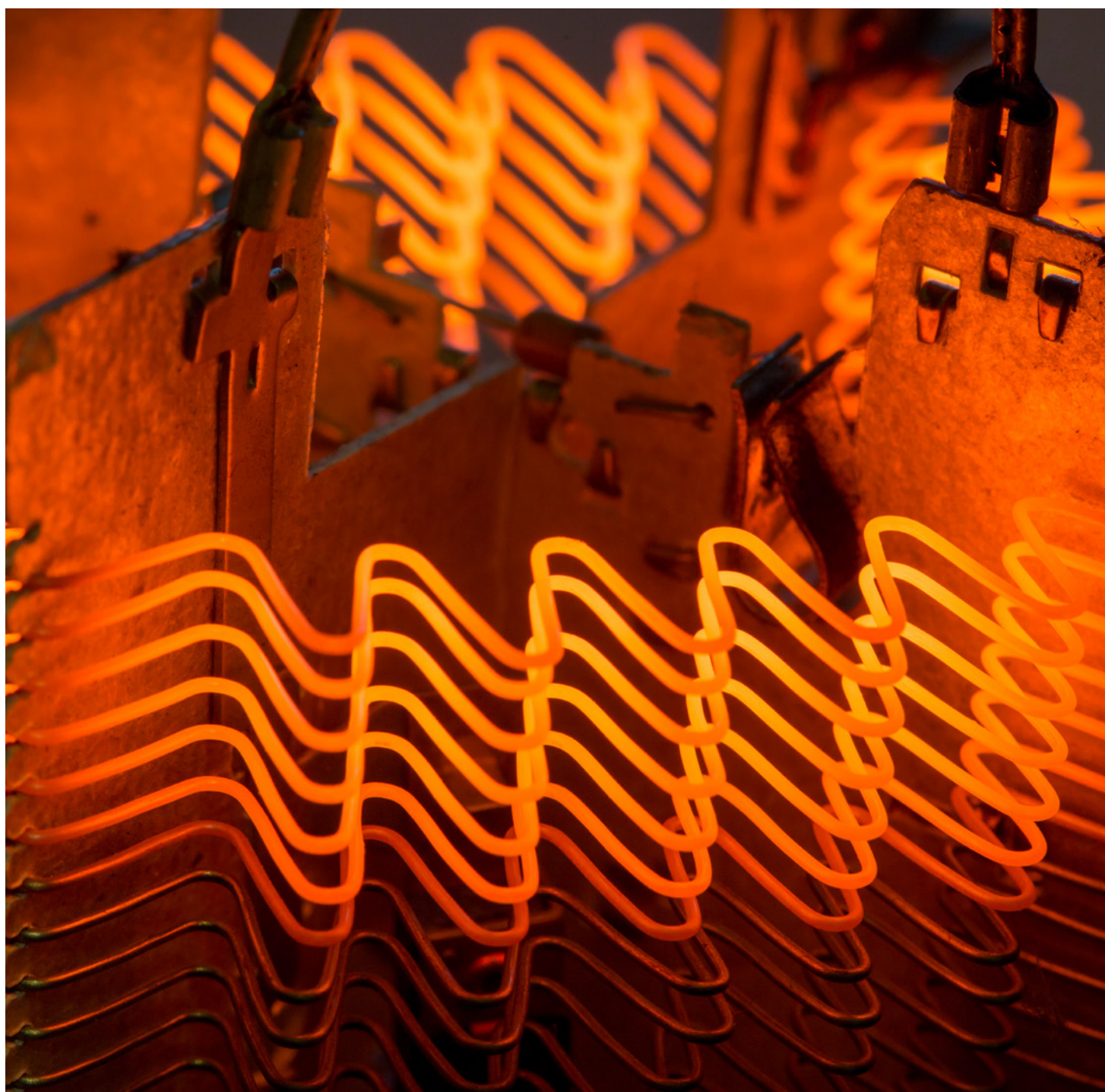



CONTENT

RESISTANCE HEATING ALLOYS	5	STANDARD TOLERANCES	35
Nickel-iron alloys (NiFe)	5	Tolerances on electrical resistance	35
Nifethal™ 70 and Nifethal 52	5	Tolerances on dimensions	35
Ferritic alloys (FeCrAl)	6	Tolerances on dimensions of cold rolled ribbon	35
Kanthal APM™, Kanthal® A-1, Kanthal A, Kanthal AF, Kanthal AE and Kanthal D, Alkrothal®	6	DELIVERY FORMS	36
Austenitic alloys (NiCr, NiCrFe)	6	Resistance heating alloys – Kanthal, Alkrothal, Nikrothal and Nifethal	36
Nikrothal® 80, Nikrothal TE, Nikrothal 70, Nikrothal 60, Nikrothal 40 and Nikrothal 20	6	Other resistance alloys – Cuprothal	38
Kanthal advantages	6	TABLES	39
Nikrothal advantages	7	Kanthal A-1 and Kanthal APM	40
Kanthal resistance heating alloys – summary	9	Kanthal A, Kanthal AF and Kanthal AE	42
Copper-nickel alloys	10	Kanthal D	48
Cuprothal® 49, (Cuprothal 30, Cuprothal 15, Cuprothal 10 and Cuprothal 05)	10	Alkrothal	54
Product varieties	11	Nikrothal 80, Nikrothal TE and Nikrothal 70	60
PHYSICAL AND MECHANICAL PROPERTIES	12	Nikrothal 60	62
Table Kanthal alloys	12	Nikrothal 40 and Nikrothal 20	64
Table Alkrothal, Nikrothal and Nifethal alloys	13	Nikrothal 80, Nikrothal 60 and Nikrothal 40 (ribbon)	66
Table Cuprothal alloys	14	Nifethal 70	70
STRANDED RESISTANCE HEATING WIRE	15	Nifethal 52	72
Strand diameter	15	Cuprothal	74
DESIGN FACTORS	17	APPENDIX	80
Operating life	17	List of symbols	80
Oxidation properties	17	Formulas and definitions	81
Corrosion resistance	17	Formulas for values in tables	83
ELEMENT TYPES AND HEATING APPLICATIONS	19	Relationship between metric and imperial units	84
The embedded element type	19	Design calculations for heating elements	86
The supported element type	19	Conversion tables	90
The suspended element type	19		
Embedded elements	20		
Supported elements	24		
Suspended elements	29		

KANTHAL® IS THE HEATING BRAND WITHIN SANDVIK

This handbook contains basic technical and product data for resistance and resistance heating alloys for the appliance industry.

We have included design, calculation and application guidelines, in order to make it easier to select the right alloy and to design the right element.

More information is given on www.kanthal.com. There you can find product news and other Kanthal product information and handbooks that can be downloaded.

Kanthal alloys are produced in a range for industrial furnaces and as ready-to-install elements and systems and as precision wire in very small sizes.

We have substantial technical and commercial resources at offices around the world and we are glad to help you with technical questions, or to try out completely new solutions at our R & D facilities.

RESISTANCE HEATING ALLOYS

The resistance heating alloys can be divided into two main groups, iron-chromium-aluminum (FeCrAl, Kanthal) and nickel-chromium (NiCr, Nikrothal®) based alloys.

For lower temperature applications copper-nickel (CuNi, Cuprothal®) and nickel-iron (NiFe, Nifethal™) based alloys are also used. All different alloys are described on the following pages as well as a comparison of some of the properties of Kanthal and Nikrothal alloys.

NICKEL-IRON ALLOYS (NiFe)

Up to 600°C (1110°F): Nifethal™ 70 and Nifethal 52 are alloys with low resistivity and high temperature coefficient of resistance. The positive temperature coefficient allows heating elements to reduce power as temperature increases. Typical applications are in low temperature tubular elements with self-regulating features.



Spools and pail pack.

FERRITIC ALLOYS (FeCrAl)

Up to 1425°C (2560°F): Kanthal APM™

is normally used in furnace applications.

Up to 1400°C (2550°F): Kanthal® A-1

is normally used in furnace applications.

Up to 1350°C (2460°F): Kanthal A

is used for appliances, where its high resistivity and good oxidation resistance are particularly important.

Up to 1300°C (2370°F): Kanthal AF

has improved hot strength and oxidation properties and is especially recommended where good form stability properties in combination with high temperature are required.

Up to 1300°C (2370°F): Kanthal AE

is developed to meet the extreme demands in fast response elements in glass top hobs and quartz tube heaters. It has exceptional form stability and life in spirals with large coil to wire diameter ratio.

Up to 1300°C (2370°F): Kanthal D

employed chiefly in appliances, its high resistivity and low density, combined with better heat resistance than austenitic alloys, make it suitable for most applications.

Up to 1100°C (2010°F): Alkrothal®

is typically specified for rheostats, braking resistors, etc. It is also used as a heating wire for lower temperatures, such as heating cables.

AUSTENITIC ALLOYS (NiCr, NiCrFe)

Up to 1200°C (2190°F): Nikrothal® 80

is the austenitic alloy with the highest nickel content. Because of its good workability and high-temperature strength, Nikrothal 80 is widely used for demanding applications in the electric appliance industry.

Up to 1200°C (2190°F): Nikrothal TE

has been developed for use in metal sheathed tubular elements operating at red hot temperatures. Suitable electrical properties and a relatively low nickel content makes Nikrothal TE an attractive alternative to alloys of higher nickel content, such as Nikrothal 80.

Up to 1250°C (2280°F): Nikrothal 70

is normally used in furnace applications.

Up to 1150°C (2100°F): Nikrothal 60

has good corrosion resistance, good oxidation properties and very good form stability. The corrosion resistance is good except in sulphur containing atmospheres. Typical applications for Nikrothal 60 are in tubular heating elements and as suspended coils.

Up to 1100 °C (2010°F): Nikrothal 40

is used as electric heating element material in domestic appliances and other electric heating equipment.

Up to 1050°C (1920°F): Nikrothal 20

will be produced on volume based request.

KANTHAL ADVANTAGES

Higher maximum temperature in air

Kanthal A-1 has a maximum temperature of 1400°C (2550°F); Nikrothal 80 has a maximum temperature of 1200°C (2190°F).

Higher surface load

Higher maximum temperature and longer life allow a higher surface load to be applied on Kanthal elements.

Higher resistivity

The higher resistivity of Kanthal alloys makes it possible to choose a material with larger cross-section, which improves the life of the element. This is particularly important for thin wire. When the same cross-section can be used, considerable weight savings are obtained. Further, the resistivity of Kanthal alloys is less affected by cold-working and heat treatment than is the case for NiCr alloys.

Higher yield strength

The higher yield strength of Kanthal alloys means less change in cross-section when coiling wires.

Longer life

Kanthal elements have a life 2–4 times the life of NiCr alloys when operated in air at the same temperature.

Better oxidation properties

The aluminum oxide (Al_2O_3) formed on Kanthal alloys adheres better and is therefore less contaminating. It is also a better diffusion barrier, better electrical insulator and more resistant to carburizing atmospheres than the chromium oxide (Cr_2O_3) formed on NiCr alloys.

Lower density

The density of Kanthal alloys is lower than that of Nikrothal alloys. This means that a greater number of equivalent elements can be made from the same weight material.

Weight savings with Kanthal alloys

The lower density and higher resistivity of Kanthal alloys means for a given power, that less material is needed when using Kanthal instead of Nikrothal alloys. In converting from NiCr to Kanthal alloys, either the wire diameter can be kept constant while changing the surface load, or the surface load can be held constant while changing the wire diameter.

The result is that in a great number of applications, substantial savings in weight and element costs can be achieved. In many cases, Kanthal alloy will weigh less than the NiCr alloy.

Better resistance to sulphur

In atmospheres contaminated with sulphuric compounds and in the presence of contaminations containing sulphur on the wire surface, Kanthal alloys have better corrosion resistance in hot state. NiCr alloys are heavily attacked under such conditions.

NIKROTHAL® ADVANTAGES

Higher hot and creep strength

Nikrothal alloys have higher hot and creep strength than Kanthal® alloys.

Kanthal APM™, Kanthal AF and Kanthal AE are better in this respect than the other Kanthal grades and have a very good form stability, however, not as good as that of Nikrothal.

Better ductility after use

Nikrothal alloys remain ductile after long use.

Higher emissivity

Fully oxidized Nikrothal alloys have a higher emissivity than Kanthal alloys. Thus, at the same surface load the element temperature of Nikrothal is somewhat lower.

Non-magnetic

In certain low-temperature applications a non-magnetic material is preferred. Nikrothal alloys are non-magnetic (except Nikrothal 60 at low temperatures). Kanthal alloys are non-magnetic above 600°C (1100°F).

Better wet corrosion resistance

Nikrothal alloys generally have better corrosion resistance at room temperature than non-oxidized Kanthal alloys. (Exceptions: atmospheres containing sulphur and certain controlled atmospheres).

KANTHAL RESISTANCE HEATING ALLOYS – SUMMARY

Maximum operating temperature per alloy

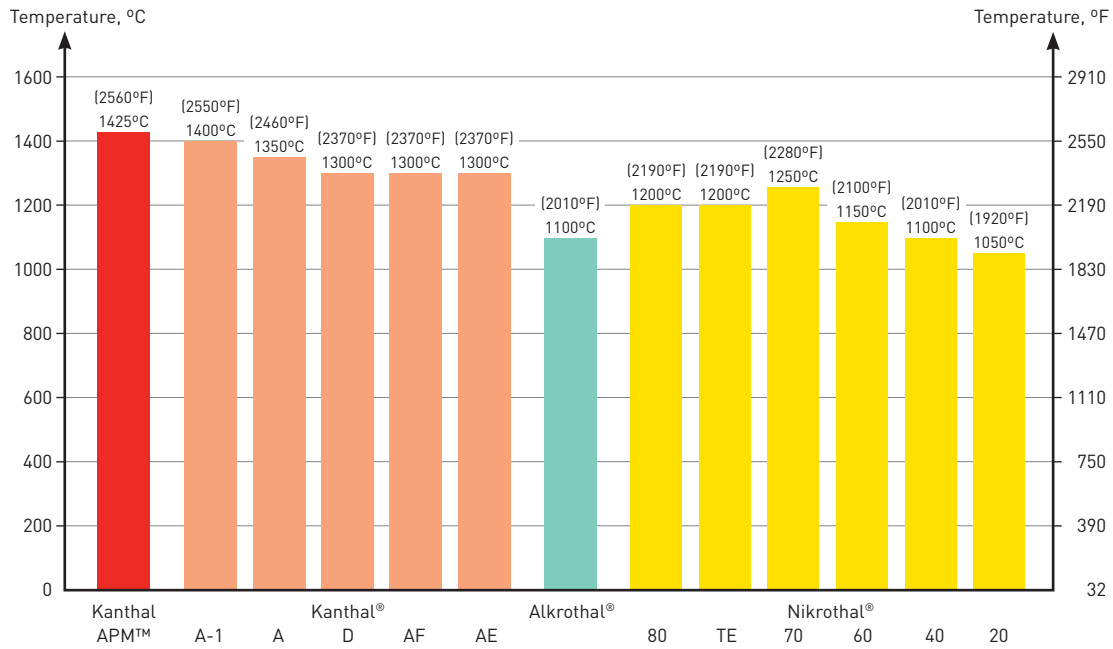

Resistivity vs. temperature

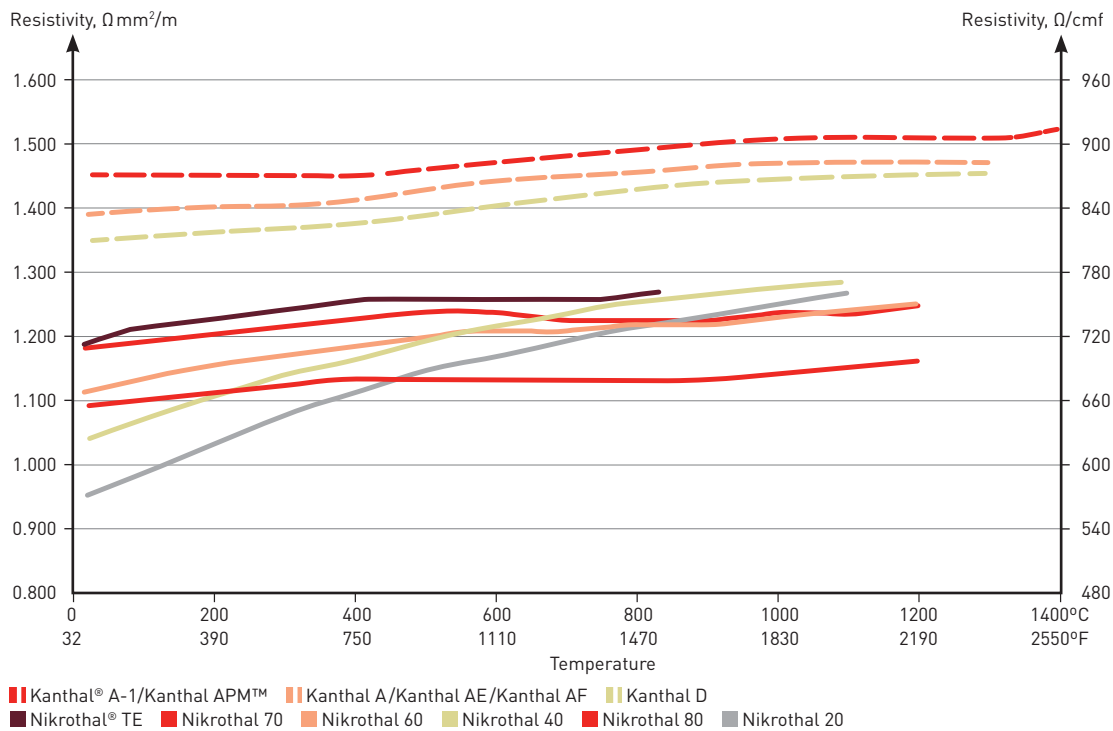

COPPER-NICKEL ALLOYS

Cuprothal® 49

(universally known as Constantan) is manufactured under controlled conditions from electrolytic copper and pure nickel.

Cuprothal 49 has a number of special characteristics – some electrical, some mechanical – which make it a remarkably versatile alloy. For certain applications, its high specific resistance and negligible temperature coefficient of resistance are the most important attributes. For others, the fact that Cuprothal 49 offers good ductility, is easily soldered and welded and has good resistance to atmospheric corrosion is more significant.

Although the range of applications of Cuprothal 49 is so wide, its normally fall into four principal categories:

- An ideal alloy for winding heavy-duty industrial rheostats and electric motor starter resistance. High specific resistance, together with good ductility and resistance to corrosion are all important requirements in this category, and Cuprothal 49 satisfies the most demanding specifications.
- Cuprothal 49 is widely used in wire-wound precision resistors, temperature-stable potentiometers, volume control devices and strain gauges. In the resistor field, its high resistance and negligible temperature coefficient of resistance are main attractions.

- The third main category of application exploits another characteristic of Cuprothal 49. This is the fact that it develops a high thermal EMF (electromotive force) against certain other metals.
- Low temperature resistance heating applications, such as heating cables.

Copper-nickel alloys with medium and low resistivity

Sandvik produces copper-nickel alloys with resistivity lower than those of Cuprothal 49. The main applications are in high current electrical resistances, fittings heating cables, electric blankets, fuses, resistors but they are also used in many other applications.

Cuprothal 30

Resistivity 30 $\mu\Omega\text{cm}$ (180 Ω/cmf)

Cuprothal 15

Resistivity 15 $\mu\Omega\text{cm}$ (90 Ω/cmf)

Cuprothal 10

Resistivity 10 $\mu\Omega\text{cm}$ (60 Ω/cmf)

Cuprothal 05

Resistivity 5 $\mu\Omega\text{cm}$ (30 Ω/cmf)



Different resistors and potentiometers using Kanthal® alloys.

PRODUCT VARIETIES

	ROD	WIRE	STRIP	RIBBON	WELDED TUBES	EXTRUDED TUBES	STRAIGHTENED WIRE
Kanthal APM™	•	•	•			•	•
Kanthal® A-1	•	•	•				•
Kanthal A		•		•			•
Kanthal D	•	•	•	•			•
Kanthal DT	•	•	•	•			•
Kanthal AF		•	•	•	•		•
Kanthal AE	•	•					•
Alkrothal®	•	•	•	•			•
Nikrothal® 80		•	•	•			•
Nikrothal TE		•					•
Nikrothal 70		•	•				•
Nikrothal 60		•	•	•			•
Nikrothal 40	•	•	•	•			•
Nikrothal 20		•					•
Nifethal™ 70		•					•
Nifethal 52		•					•
Cuprothal® 49	•	•	•	•			•
Cuprothal 30		•					•
Cuprothal 15		•					•
Cuprothal 10		•					•
Cuprothal 05		•					•

PHYSICAL AND MECHANICAL PROPERTIES

		KANTHAL APM™	KANTHAL® A-1	KANTHAL A	KANTHAL AF	KANTHAL AE	KANTHAL D
Max continuous operating temp. (element temperature in air)	°C (°F)	1425 (2600)	1400 (2550)	1350 (2460)	1300 (2370)	1300 (2370)	1300 (2370)
Nominal composition (See Note), %	Cr	22	22	22	22	22	22
	Al	5.8	5.8	5.3	5.3	5.3	4.8
	Fe	balance	balance	balance	balance	balance	balance
	Ni	–	–	–	–	–	–
Density ρ	g/cm ³ (lb/in ³)	7.10 (0.256)	7.10 (0.256)	7.15 (0.258)	7.15 (0.258)	7.15 (0.258)	7.25 (0.262)
Resistivity at 20°C at 68°F	Ω mm ² /m (Ω /cmf)	1.45 (872)	1.45 (872)	1.39 (836)	1.39 (836)	1.39 (836)	1.35 (812)
Temperature factor of the resistivity, Ct							
250°C (480°F)		1.00	1.00	1.01	1.01	1.01	1.01
500°C (930°F)		1.01	1.01	1.03	1.03	1.03	1.03
800°C (1470°F)		1.03	1.03	1.05	1.05	1.05	1.06
1000°C (1830°F)		1.04	1.04	1.06	1.06	1.06	1.07
1200°C (2190°F)		1.05	1.04	1.06	1.06	1.06	1.08
Linear thermal expansion coefficient α, $\times 10^{-6}/K$							
20–100°C (68–210°F)		–	–	–	–	–	–
20–250°C (68–480°F)		11	11	11	11	11	11
20–500°C (68–930°F)		12	12	12	12	12	12
20–750°C (68–1380°F)		14	14	14	14	14	14
20–1000°C (68–1840°F)		15	15	15	15	15	15
Thermal conductivity λ at 50°C at 122°F	W/m K (Btu in/ft ² h °F)	11 (76)	11 (76)	11 (76)	11 (76)	11 (76)	11 (76)
Specific heat capacity at 20°C at 68°F	kJ/kg K (Btu/lb °F)	0.46 (0.110)	0.46 (0.110)	0.46 (0.110)	0.46 (0.110)	0.46 (0.110)	0.46 (0.110)
Melting point (approx.)	°C (°F)	1500 (2730)	1500 (2730)	1500 (2730)	1500 (2730)	1500 (2730)	1500 (2730)
Mechanical properties* (approx.)							
Tensile strength	N/mm ² (psi)	680** (98600**)	680 (98600)	725 (105200)	700 (101500)	720 (104400)	670 (97200)
Yield point	N/mm ² (psi)	470** (68200**)	545 (79000)	550 (79800)	500 (72500)	520 (74500)	485 (70300)
Hardness	Hv	230	240	230	230	230	230
Elongation at rupture	%	20**	20	22	23	20	22
Tensile strength at 900°C at 1650°F	N/mm ² (psi)	40 (5800)	34 (4900)	34 (4900)	37 (5400)	34 (4900)	34 (4900)
Creep strength***							
at 800°C at 1470°F	N/mm ² (psi)	8.2 (1190)	1.2 (170)	1.2 (170)	– (–)	1.2 (170)	1.2 (170)
at 1000°C at 1830°F	N/mm ² (psi)	– (–)	0.5 (70)	0.5 (70)	– (–)	– (–)	0.5 (70)
at 1100°C at 2010°F	N/mm ² (psi)	– (–)	– (–)	– (–)	0.7 (100)	– (–)	– (–)
at 1200°C at 2190°F	N/mm ² (psi)	– (–)	– (–)	– (–)	0.3 (40)	– (–)	– (–)
Magnetic properties		1)	1)	1)	1)	1)	1)
Emissivity, fully oxidized condition		0.70	0.70	0.70	0.70	0.70	0.70

Note: Composition listed is nominal. Actual composition may vary to meet standard electrical resistance and dimensional tolerances.

* The values given apply for sizes of approx. 1.0 mm diameter (0.039 in)

** 4.0 mm (0.157 in) Thinner gauges have higher strength and hardness values while the corresponding values are lower for thicker gauge

*** Calculated from observed elongation in a Kanthal standard furnace test. 1% elongation after 1000 hours

**** Composition listed is nominal. Actual composition may vary to meet standard electrical resistance and dimensional tolerances.

ALKROTHAL®	NIKROTHAL® 80	NIKROTHAL TE	NIKROTHAL 70	NIKROTHAL 60	NIKROTHAL 40	NIKROTHAL 20	NIFETHAL™ 70	NIFETHAL 52
1100 (2010)	1200 (2190)	1200 (2190)	1250 (2280)	1150 (2100)	1100 (2010)	1050 (1920)	600 (1110)	600 (1110)
15 4.3 balance –	20 – – 80	22 – 9 balance	30 – – 70	16 – balance 60	20 – balance 35	24 – balance 20	– – balance 72	– – balance 52
7.28 (0.263)	8.30 (0.300)	8.10 (0.293)	8.10 (0.293)	8.20 (0.296)	7.90 (0.285)	7.80 (0.281)	8.45 (0.305)	8.20 (0.296)
1.25 (744)	1.09 (655)	1.19 (716)	1.18 (709)	1.11 (668)	1.04 (626)	0.95 (572)	0.20 (120)	0.376 (220)
1.02 1.05 1.10 1.11 –	1.02 1.05 1.04 1.05 1.07	1.04 1.06 1.06 1.07 1.07	1.02 1.05 1.04 1.05 1.06	1.04 1.08 1.10 1.11 –	1.08 1.15 1.21 1.23 –	1.12 1.21 1.28 1.32 –	2.19 3.66 – – –	1.93 2.77 – – –
– 11 12 14 15 16 0.46 1500	– 15 16 17 18 15 0.46 1400	– 14 15 16 17 14 0.46 1380	– 14 15 16 17 14 0.46 1380	– 16 17 18 18 14 0.46 1390	– 16 17 18 19 13 0.50 1390	– 16 17 18 19 13 0.50 1380	– – 13 – 15 17 0.52 1430	10 – – – – 17 0.52 1435
630 (91400)	810 (117500)	800 (116000)	820 (118900)	730 (105900)	675 (97900)	675 (97500)	640 (92800)	610 (88500)
455 (66000)	420 (60900)	390 (56600)	430 (62400)	370 (53700)	340 (49300)	335 (48600)	340 (49300)	340 (49300)
220 22 30	180 30 100	190 30 –	185 30 120	180 35 100	180 35 120	160 30 120	– – –	– 30 –
4300)	(14500)	–	(17400)	(14500)	(17400)	(17400)	–	–
1.2 (170)	15 (2160)	15 (2160)	– –	15 (2160)	20 (2900)	20 (2900)	– –	– –
1 (140)	4 (560)	4 (560)	– –	4 (560)	4 (560)	4 (560)	– –	– –
– – – –	– – – –	– – – –	– – – –	– – – –	– – – –	– – – –	– – – –	– – – –
1) 0.70	2) 0.88	2) 0.88	2) 0.88	3) 0.88	2) 0.88	2) 0.88	4) 0.88	5) 0.88

1) Magnetic [Curie point approx. 600°C (1100°F)]
2) Non-magnetic
3) Slightly magnetic
4) Magnetic up to 610°C (1130°F) [Curie point]
5) Magnetic up to 530°C (990°F) [Curie point]
6) ± 10%

		CUPROTHAL® 49	CUPROTHAL 30	CUPROTHAL 15	CUPROTHAL 10	CUPROTHAL 05
Nominal composition, %	Ni	44	21	11	6	2
	Cu	balance	balance	balance	balance	balance
	Fe	+	-	-	-	-
	Mn	1	1.5	-	-	-
Density ρ	g/cm ³ (lb/in ³)	8.90 (0.321)	8.90 (0.321)	8.90 (0.321)	8.90 (0.321)	8.90 (0.321)
Resistivity at 20°C at 68°F	Ω mm ² /m (Ω/cm ²)	0.49 (295)	0.30 (180)	0.15 (90)	0.10 (60)	0.05 (30)
Temperature factor of the resistivity, C_t -55 – 150°C (-67 – 300°F) 20 – 105°C (68 – 220°F)		±20/±60	250	400	700	1300
Temperature range	°C (°F)	-55 – 150 (-67 – 300)	20 – 105 (68 – 220)	20 – 105 (68 – 220)	20 – 105 (68 – 220)	20 – 105 (68 – 220)
Linear thermal expansion coefficient α, × 10⁻⁶/K 20 – 100°C (68 – 210°F)		14	16	16	16	16.5
Thermal conductivity λ at 50°C at 122°F	W/mK (Btu in/ft ² h°F)	21 (146)	35 (243)	60 (460)	90 (624)	130 (901)
Specific heat capacity at 20°C at 68°F	kJ/kg K (Btu/lb°F)	0.41 (0.098)	0.37 (0.088)	0.38 (0.091)	0.38 (0.091)	0.38 (0.091)
Melting point (approx.)	°C (°F)	1280 (2336)	1150 (2102)	1100 (2012)	1095 (2003)	1090 (1994)
Mechanical properties* (approx.)						
Tensile strength, min	N/mm ² (psi)	420 (60900)	340 (49300)	250 (36200)	230 (33350)	220 (31900)
Tensile strength, max	N/mm ² (psi)	690 (100100)	690 (100100)	540 (78300)	680 (98600)	440 (63800)
Elongation at rupture	%	30	30	30	30	30
Magnetic properties	non-magnetic non-magnetic non-magnetic non-magnetic non-magnetic					

STRANDED RESISTANCE HEATING WIRE



Recognizing the need for more precisely controlled stranded wire within the heat treatment industry and working closely with our cable customers, Sandvik has developed a range of stranded resistance wires in the well known Nikrothal®, Kanthal® and nickel alloys.

These alloys possess the optimum properties for high performance at elevated temperatures and in other adverse conditions where reliability and quality is of paramount consideration.

ALLOY	NOMINAL COMPOSITION, %					RESISTIVITY AT 20°C (68°F) MAX. TEMP*			
	NI	CR	FE	AL	MN	ΩMM ² /M	Ω/CMF	°C	°F
Nikrothal® 80	80	20				1.09	655	1200	2190
Nikrothal 60	60	16	balance			1.11	668	1150	2100
Kanthal® D		22	balance	4.8		1.35	812	1300	2370
Kanthal AF		22	balance	5.3		1.39	836	1300	2370
Nickel	99.2					0.09	54		
NiMn	98				2	0.11	66		

* Values given apply for sizes approx. 1.0 mm (0.039 in)

STRAND DIAMETER

Nominal diameter to be determined from single-end wire diameters, which have to meet resistance requirements. Resistance generally takes priority over diameter. The calculation is:

Strand normal diameter = single-end diameter × F

F = 3 for 7-strand

F = 5 for 19-strand true concentric

F = 7 for 37-strand true concentric

Size range

Up to 37 wires (ends) of diameter between 0.20–0.85 mm (0.008–0.033 in).

True concentric

Successive layers have different lay directions and lay length.



Unilayer

Successive layers have the same lay directions and lay length.

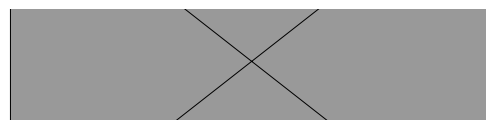

Unidirectional concentric

Successive layers have the same lay directions and increasing lay length.



STANDARD STOCK MATERIAL

ALLOY	TOTAL DIAM. NOMINAL		NO. OF STRANDS × SIZE		KING WIRE SIZE		RESISTANCE		LENGTH		WEIGHT	
		IN	MM	IN	MM	IN	Ω/M	Ω/FT	M/KG	FT/LB	G/M	LB/FT
Nikrothal® 80	2.76	0.109	37×0.385	37×0.0152	0.450	0.0177	0.2794	0.0852	28	41.67	36	0.0242
Nikrothal 80	2.67	0.105	19×0.523	19×0.0206	0.574	0.0226	0.2850	0.0869	29	43.16	34	0.0228
Nikrothal 80	2.67	0.105	19×0.544	19×0.0214	0.574	0.0226	0.2648	0.0807	27	40.18	37	0.0249
Nikrothal 80	2.87	0.113	19×0.574	19×0.0226	0.574	0.0226	0.2394	0.0730	25	37.20	41	0.0276
Nikrothal 60	2.76	0.109	19×0.523	19×0.0206	0.574	0.0226	0.2902	0.0885	30	44.64	34	0.0228
Nickel	2.87	0.113	19×0.574	19×0.0226	0.574	0.0226	0.0198	0.0060	21	31.25	47	0.0320
NiMn ²	2.87	0.113	19×0.574	19×0.0226	0.710	0.0280	0.0234	0.0071	22	32.74	45	0.0305
NiMn ²	2.87	0.113	18×0.610	18×0.0240	–	0.0280	0.0210	0.0064	19	28.28	53	0.0354

FLEXIBLE TERMINALS FOR INDUSTRIAL APPLICATIONS

		FLEX SIZE				
		X SMALL	SMALL	MEDIUM	LARGE	X LARGE
Flex Ø	mm (in)	2.3 (0.091)	3.75 (0.148)	4.2 (0.165)	6.7 (0.264)	9.3 (0.366)
CSA	mm ² (in ²)	3.18 (0.005)	8.40 (0.013)	10.78 (0.017)	21.65 (0.034)	38.48 (0.060)
Strands	mm (in)	7×0.76 (0.27×0.0299)	19×0.75 (0.75×0.0295)	19×0.85 (0.75×0.0335)	49×0.75 (1.93×0.0295)	49×1.00 (1.93×0.0394)
Weight	g/m (lb/ft)	26.24 (0.018)	70 (0.047)	86 (0.058)	184 (0.124)	325 (0.218)
Current, A low temp. <400°C (<750°F)		7	15	22	44	77
Current, A high temp. >400°C (>750°F)		5	15	20	30	45
Cold resistivity RcΩ/m		0.347	0.106	0.102	0.050	0.028

CSA = Cross sectional area

Other stranded wire dimensions and configurations can be supplied on request.

DESIGN FACTORS

OPERATING LIFE

The life of the resistance heating alloy is dependent on a number of factors, among them the most important are:

- temperature
- temperature cycling
- contamination
- alloy composition
- trace elements and impurities
- wire diameter
- surface condition
- atmosphere
- mechanical stress
- method of regulation

Since these are unique for each application it is difficult to give general guidelines of life expectations. Recommendations on some of the important design factors are given below.

OXIDATION PROPERTIES

When heated, resistance heating alloys form an oxide layer on their surface, which slows down further oxidation of the material. To accomplish this function the oxide layer must be dense and resist the diffusion of gases as well as metal ions. It must also be thin and adhere to the metal under temperature fluctuations.

The protective oxide layer on Kanthal® alloys formed at temperatures above 1000°C (1830°F) consists mainly of alumina (Al₂O₃). The color is light grey, while at lower temperatures (under 1000°C (1830°F)) the oxide color becomes darker. The alumina layer has excellent electrical insulating properties and good chemical resistance to most compounds.

The oxide formed on Nikrothal® alloys consists mainly of chromium oxide (Cr₂O₃). The color is dark and the electrical insulating properties inferior to those of alumina.

The oxide layer on Nikrothal alloys spalls and evaporates more easily than the tighter oxide layer that is formed on Kanthal alloys.

Results of several life tests according to ASTM B 78 (modified) are given in a table for Kanthal and Nikrothal alloys. In the table, the durability of Kanthal A-1 wire at 1200°C (2190°F) is set at 100%, and the durability of the other alloys is related to that figure.

Relative durability values in % Kanthal and Nikrothal alloys (ASTM-test wire 0.7 mm (0.028 in))

ALLOY	1100°C (2010°F)	1200°C (2190°F)	1300°C (2370°F)
Kanthal® A-1	340	100	30
Kanthal AF	465	120	30
Kanthal AE	550	120	30
Kanthal D	250	75	25
Nikrothal® 80	120	25	–
Nikrothal TE	130	25	–
Nikrothal 60	95	25	–
Nikrothal 40	40	15	–

Kanthal A-1 at 1200°C (2190°F) is set at 100%

CORROSION RESISTANCE

Corrosive or potentially corrosive constituents can considerably shorten wire life. Perspiring hands, mounting or supporting materials or contamination can cause corrosion.

STEAM

Steam shortens the wire life. This effect is more pronounced on Nikrothal alloys than on Kanthal alloys.

HALOGENS

Halogens (fluorine, chlorine, bromine and iodine) severely attack all high-temperature alloys at fairly low temperatures.

SULPHUR

In sulphurous atmospheres Kanthal® alloys have considerably better durability than nickel-based alloys. Kanthal is particularly stable in oxidizing gases containing sulphur, while reducing gases with a sulphur content diminish its service life.

Nikrothal® alloys are sensitive to sulphur.

SALTS AND OXIDES

The salts of alkaline metals, boron compounds, etc. in high concentrations are harmful to resistance heating alloys.

METALS

Some molten metals, such as zinc, brass, aluminum and copper, react with the resistance alloys. The elements should therefore be protected from splashes of molten metals.

CERAMIC SUPPORT MATERIAL

Special attention must be paid to the ceramic supports that come in direct contact with the heating wire. Firebricks for wire support should have an alumina content of at least 45%. In high-temperature applications, the use of sillimanite and high-alumina firebricks is often recommended. The free silica (uncombined quartz) content should be held low. Iron oxide (Fe₂O₃) content must be as small as possible, preferably below 1%.

Water glass as a binder in cements must be avoided.

EMBEDDING COMPOUNDS

Most embedding compounds including ceramic fibers are suitable for Kanthal and Nikrothal if composed of alumina, alumina-silicate, magnesia or zircon

MAXIMUM WIRE TEMPERATURES AS A FUNCTION OF WIRE DIAMETER WHEN OPERATING IN AIR

ALLOY	DIAMETER							
	0.15–0.40 MM °C	0.0059–0.0157 IN °F	0.41–0.95MM °C	0.0161–0.0374 IN °F	1.0–3.0 MM °C	0.039–0.18 IN °F	>3.0 MM °C	>0.118 IN °F
Kanthal® AF	900–1100	1650–2010	1100–1225	2010–2240	1225–1275	2240–2330	1300	2370
Kanthal A	925–1050	1700–1920	1050–1175	1920–2150	1175–1250	2150–2280	1350	2460
Kanthal AE	950–1150	1740–2100	1150–1225	2100–2240	1225–1250	2240–2280	1300	2370
Kanthal D	925–1025	1700–1880	1025–1100	1880–2010	1100–1200	2010–2190	1300	2370
Nikrothal® 80	925–1000	1700–1830	1000–1075	1830–1970	1075–1150	1970–2100	1200	2190
Nikrothal TE	925–1000	1700–1830	1000–1075	1830–1970	1075–1150	1970–2100	1200	2190
Nikrothal 60	900–950	1650–1740	950–1000	1740–1830	1000–1075	1830–1970	1150	2100
Nikrothal 40	900–950	1650–1740	950–1000	1740–1830	1000–1050	1830–1920	1100	2010

ELEMENT TYPES AND HEATING APPLICATIONS

THE EMBEDDED ELEMENT TYPE

The wire in the embedded element type is completely surrounded by solid or granular insulating material.

METAL SHEATHED TUBULAR ELEMENTS

Kanthal D is generally the best heating wire for tube temperatures below 700°C (1290°F), and Nikrothal 80 or Nikrothal TE for temperatures above.

To use Kanthal instead of NiCr gives the following advantages:

- Lower wire weight by some 20–30% at the same wire dimension.
- More uniform temperature along the element and lower maximum wire temperature. This means that the element can be charged higher for a short time – important when there is a risk of dry boiling.
- Closer tolerances of rating. Rating and temperature remains more constant since the resistivity in hot state does not change as much as for NiCr.
- Longer life at high surface loads. The element life is also easier forecasted.
- Kanthal is easier to manufacture when high resistance per length is needed, since a thicker wire can be used.
- Less sensitive to corrosion attacks.

THE SUPPORTED ELEMENT TYPE

The wire, normally in coil form, is situated on the surface, in a groove or a hole of the electrical insulating material.

Generally Kanthal AE, Kanthal AF and Nikrothal 80 are the most suitable materials.

In order to avoid deformations on horizontal coils, the wire temperature should not exceed the values given in the diagram on this page.

THE SUSPENDED ELEMENT TYPE

The wire is suspended freely between insulated points and is exposed to the mechanical stress caused by its own weight, its own spring force and in some cases also from the forces of an external spring.

Kanthal D, Kanthal AF, Nikrothal 80 and Nikrothal 60 are the most suitable materials.

PERMISSIBLE D/D (COIL DIAMETER/WIRE DIAMETER) RATIOS AS A FUNCTION OF WIRE TEMPERATURE IN SUPPORTED COIL ELEMENTS

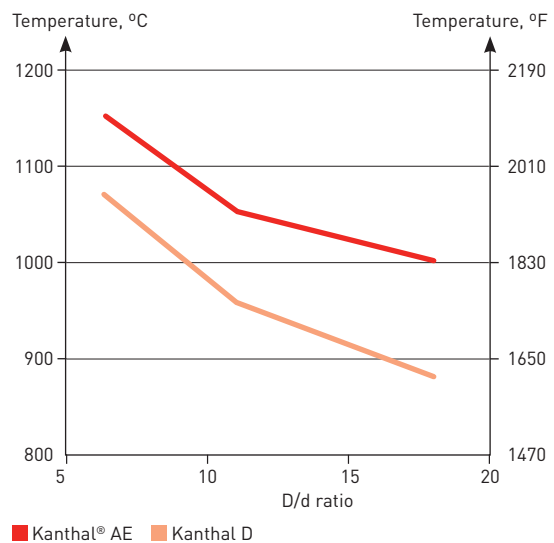

COILS IN GROOVED METAL PLATES



CHARACTERISTICS

Heating coil and insulating powder are pressed into grooves of a metal plate.

RECOMMENDED ALLOY

Kanthal® D.

SURFACE LOAD

Wire: 4–20 W/cm² [26–129 W/in²].

TYPICAL APPLICATIONS

Cast iron plates, irons, warming plates, kettles, domestic ovens.

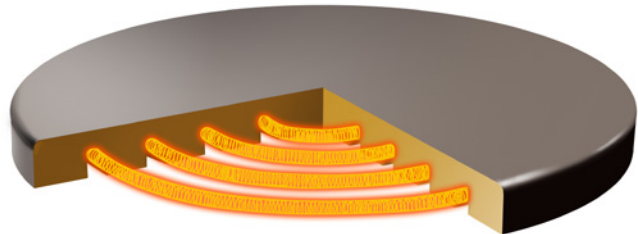

CARTRIDGE ELEMENTS, POWDER FILLED



CHARACTERISTICS

Straight wire or coil is wound on a threaded ceramic body and insulated by granular insulating material (MgO) from an enveloping metal tube. Terminals are at one end of the element. Elements are compressed when high-loaded.

RECOMMENDED ALLOYS

Nikrothal® 80 in straight wire elements.

Kanthal D in coiled wire elements.

SURFACE LOAD

On tube: 10–25 W/cm² [65–161 W/in²] for elements with straight wire.

Other types: about 5 W/cm² [32 W/in²].

TYPICAL APPLICATIONS

Metal dies, plates, refrigerators.

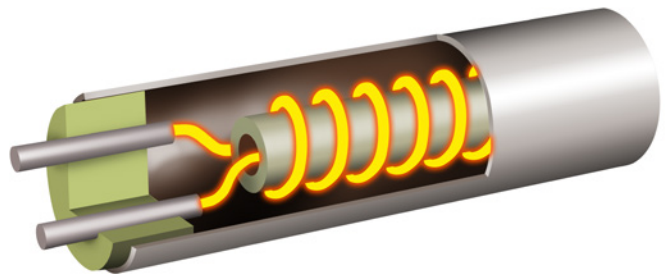

HEATING CABLES AND ROPE HEATERS



CHARACTERISTICS

Wire is wound on a fiberglass core and insulated by PVC or silicone rubber (higher temperatures). Fiberglass insulation permits even higher temperatures. Heating cables with straight or stranded wires, sometimes enclosed in aluminum tube, also occur.

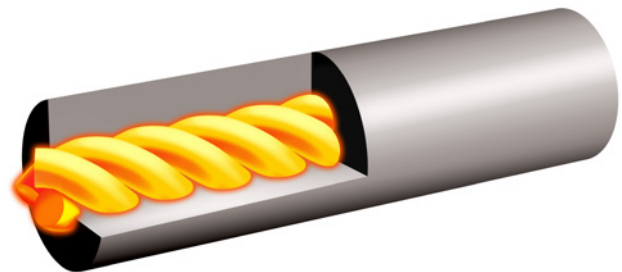

RECOMMENDED ALLOYS

Kanthal® D.
Nikrothal® 40 and Nikrothal 80.
Cuprothal® 30, Cuprothal 10 and Cuprothal 49.

SURFACE LOAD

Wire:
<math><1 \text{ W/cm}^2</math> (<math><6 \text{ W/in}^2</math>) on wire for PVC and silicone rubber,
$2\text{--}5 \text{ W/cm}^2$ ($13\text{--}32 \text{ W/in}^2$) for fiberglass insulation.

TYPICAL APPLICATIONS

Defrosting and de-icing elements, electric blankets and pads, car seat heaters, baseboard heaters, floor heating.

MICA ELEMENTS



CHARACTERISTICS

Resistance ribbon or wire is wound on a mica sheet or tube and insulated by mica. Elements are often encapsulated in steel sheaths.

RECOMMENDED ALLOYS

Kanthal D.
Nikrothal 80.

SURFACE LOAD

Wire: 2–10 W/cm² (13–65 W/in²).

TYPICAL APPLICATIONS

Irons, ironing machines, water heaters, plastic molding dies, soldering irons.

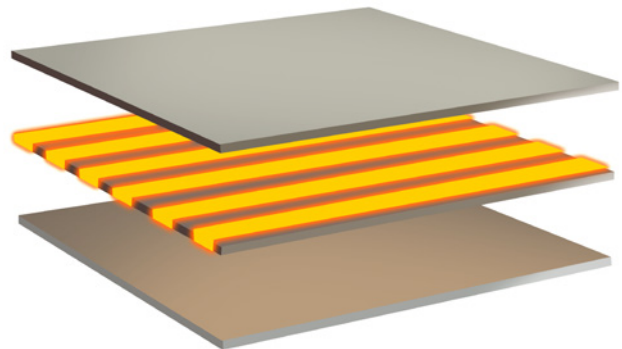

CERAMIC CARTRIDGE ELEMENTS



CHARACTERISTICS

Most common design consists of round ceramic bodies with longitudinal holes or grooves for heating coil. Elements are often in metallic tube with terminals at one end.

Often provisions are made to avoid excessive sagging of the coil when the element is operating vertically.

RECOMMENDED ALLOYS

Kanthal[®] A or Kanthal D for horizontally operating coils.
Nikrothal[®] 80 (usually) for long vertically situated coils when sagging is a problem.

SURFACE LOAD

Wire: 3–6 W/cm² (20–40 W/in²).
Element: 2–5 W/cm² (19–39 W/in²).

TYPICAL APPLICATIONS

Liquid heating, storage heaters.

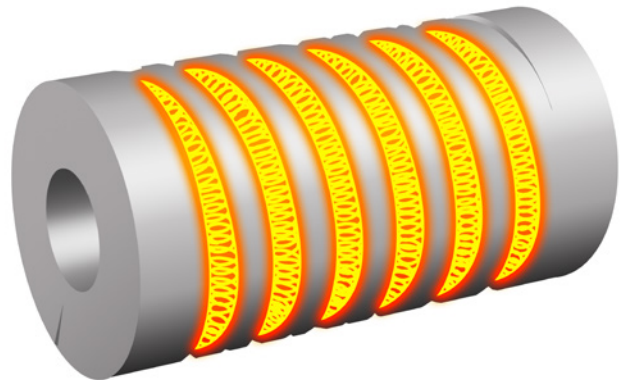

OTHER CERAMIC ELEMENTS



CHARACTERISTICS

Coiled and straight wire is located on smooth ceramic tube or in grooves or holes of ceramic bodies of various shapes (plates, tubes, rods, cylinders, etc.).

RECOMMENDED ALLOYS

Kanthal A, Kanthal AF and Kanthal D.
Nikrothal 80 (for pencil bars).

SURFACE LOAD

Wire: 3–9 W/cm² (19–58 W/in²).

TYPICAL APPLICATIONS

Boiling plates, air guns, hobby kilns, radiators.

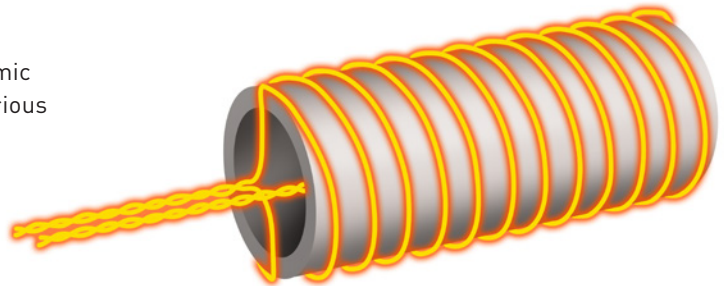

QUARTZ TUBE HEATERS



CHARACTERISTICS

Heating coil or porcupine shaped wire is placed inside quartz tube (or tube of glass ceramic).

When the element is operating vertically or at an angle, the coil should be tight-wound and pre-oxidized.

For horizontal use, the relative pitch is 1.2–2.0.

RECOMMENDED ALLOYS

Kanthal® AF and Kanthal AE.

SURFACE LOAD

Wire: 2–8 W/cm² (13–52 W/in²).

Element: 4–8 W/cm² (26–52 W/in²).

TYPICAL APPLICATIONS

Space heating, infrared heaters, toasters, toaster ovens, grills, industrial infrared dryers etc.

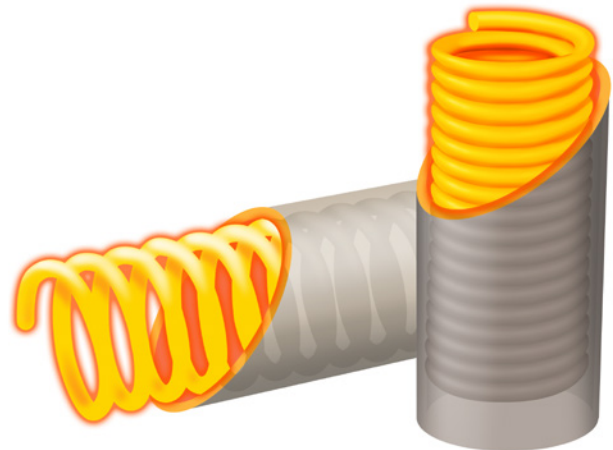

BEAD INSULATED COILS OR STRANDED WIRE



CHARACTERISTICS

Heating coil, or stranded wire, is insulated by ceramic beads. With beads having two holes heating mats are made.

RECOMMENDED ALLOYS

Kanthal D.
Nikrothal® 80 (for panel heaters).

SURFACE LOAD

Wire: 1–8 W/cm² (6–52 W/in²).

TYPICAL APPLICATIONS

Mats for in-situ annealing of welded parts, panel heaters, waffle irons, domestic ovens, water heater.

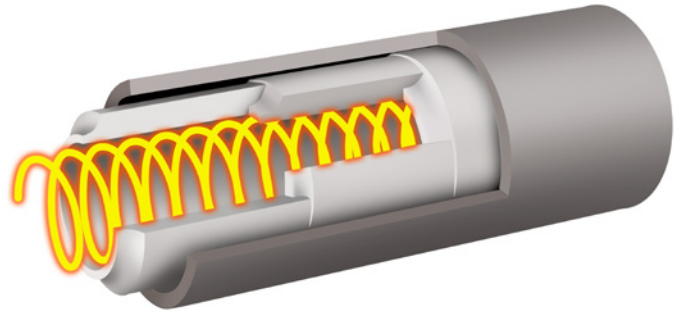

STRING ELEMENTS



CHARACTERISTICS

Heating wire wound on insulated steel wire (approx. 2 mm (0.079 in)) or fiber glass cord.

RECOMMENDED ALLOY

Kanthal® D.

SURFACE LOAD

Wire: <math><10\text{ W/cm}^2</math>.

TYPICAL APPLICATIONS

Stationary hair dryers.

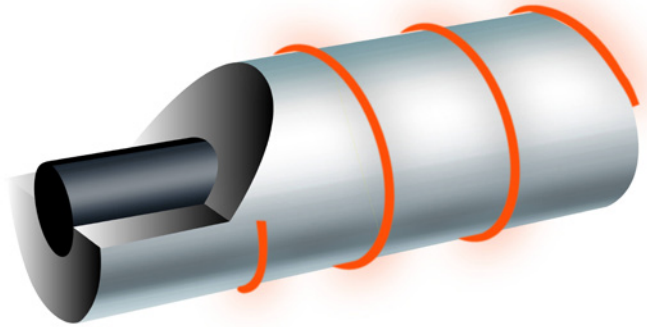

SUSPENDED COILS



CHARACTERISTICS

Wire coil is supported at intervals, e.g. by ceramic holders. Fiberglass cord is often placed inside coil to prevent the coil from falling down in case of element failure.

RECOMMENDED ALLOYS

Nikrothal® 80 and Nikrothal 60.
Kanthal D and Kanthal AF (mainly for wire temperatures below 600°C, where sagging is no problem).

SURFACE LOAD

Wire:
7–8 W/cm² in forced air,
3–4 W/cm² in natural convection.

TYPICAL APPLICATIONS

Air heaters such as: laundry dryers, fan heaters, land dryers.

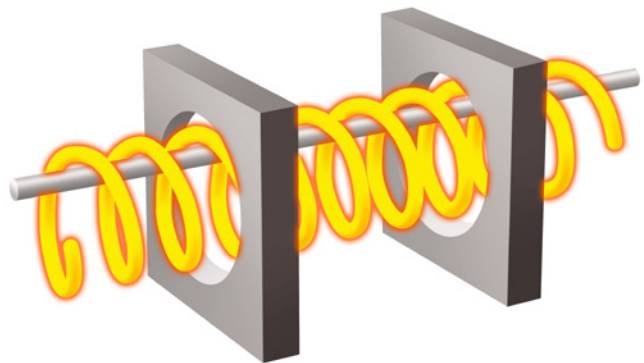

SUSPENDED STRAIGHT WIRES AND RIBBONS



CHARACTERISTICS

Wire or ribbon may have elastic or fixed suspension.
Elastic: Wire kept straight by springs when heated.
Fixed: Operating temperature is lower and low thermal expansion is advantageous.

RECOMMENDED ALLOYS

Kanthal[®] A and Kanthal AF (low thermal expansion).
Nikrothal[®] 80.

SURFACE LOAD

Wire: 4–12 W/cm² [26–77 W/in²].

TYPICAL APPLICATIONS

Radiators, convection heaters, hair dryers.

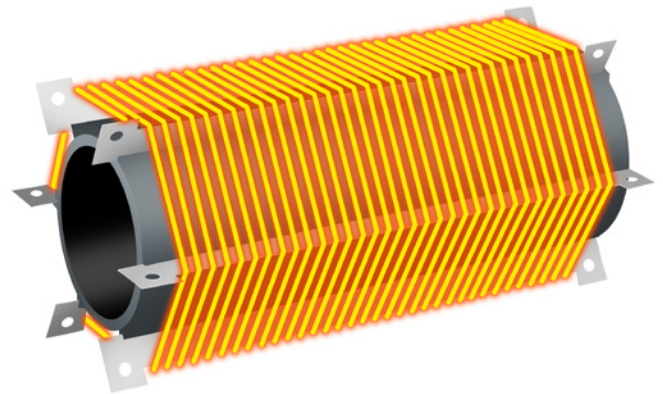

OPEN MICA ELEMENTS



CHARACTERISTICS

Straight or corrugated heating wire or ribbon is wound on one or both sides of a mica sheet or separated mica strips. Ribbons are frequently used in this application.

RECOMMENDED ALLOYS

Nikrothal 80 and Nikrothal 60.
Kanthal D and Kanthal AF.

SURFACE LOAD

Wire: 4–7 W/cm² (26–45 W/in²).
For toasters: <13 W/cm² (<84 W/in²) for wire-wound elements.

TYPICAL APPLICATIONS

Toasters, convection heating, low-watt aquarium heaters.

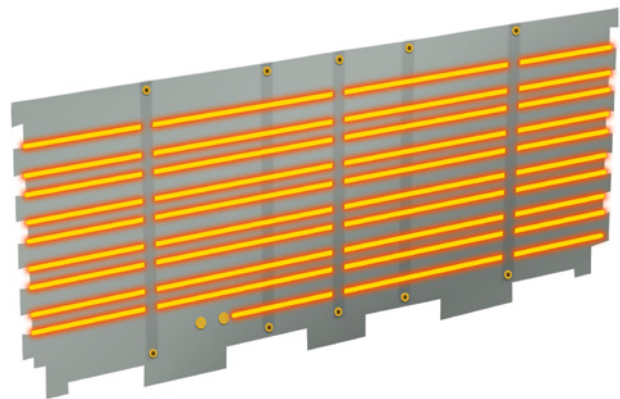

ZIGZAG ELEMENTS



CHARACTERISTICS

Deep-corrugated ribbon is supported by mica sheets.
Also radial shape.

RECOMMENDED ALLOYS

Kanthal[®] D and Kanthal AF.
Nikrothal[®] 40.

SURFACE LOAD

Wire: 9 W/cm² (58 W/in²).

TYPICAL APPLICATIONS

Fan heaters, convection heating.

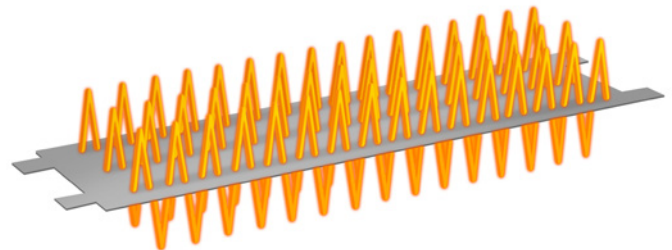

PORCUPINE ELEMENTS



CHARACTERISTICS

Heating conductor consists of hairpin-shaped wire bends protruding in all directions, with hole in center. Element is supported by central insulated rod or insulating tube around its circumference.

RECOMMENDED ALLOYS

Kanthal AF.
Kanthal AE (below 1 mm).
Nikrothal 80.

SURFACE LOAD

Wire: 4 W/cm² (26 W/in²) in natural convection.
For toasters: 12 W/cm² (77 W/in²) in forced convection.

TYPICAL APPLICATIONS

Hot air guns, radiators, convectors, tumble dryers, domestic ovens with forced convection.

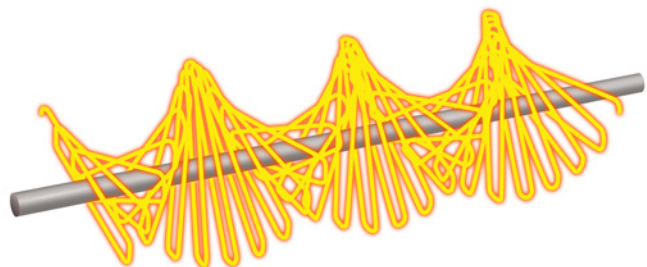

COILS IMMERSED IN WATER



CHARACTERISTICS

Wire coils supported by a plastic cage operating directly in water.

RECOMMENDED ALLOYS

Kanthal[®] D and Kanthal AF.
Nikrothal[®] 80.

SURFACE LOAD

Wire: Depending on water velocity, 20–60 W/cm²
(129–387 W/in²) (even higher figures occur).

TYPICAL APPLICATIONS

Instantaneous tap water and shower heaters,
steam generators.

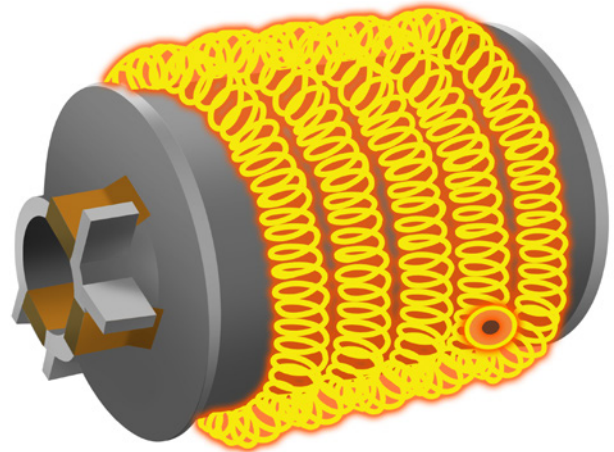

STANDARD TOLERANCES

Standard tolerances for wire and ribbon are given below. Size tolerances do not apply to material manufactured to resistance tolerances and vice-versa.

TOLERANCES ON ELECTRICAL RESISTANCE

RESISTANCE OF WIRE AT 20°C (68°F)

Diameter ≤ 0.127 mm (0.005 in) $\pm 8\%$.

All dimensions > 0.127 mm (0.005 in) $\pm 5\%$.

RESISTANCE OF RIBBON

For cold rolled strips and ribbon, all widths and thickness' $\pm 5\%$.

TOLERANCES ON DIMENSIONS

TOLERANCES ON DIAMETER OF WIRE ACCORDING TO THE EN 10 218-2 T4 STANDARD

WIRE SIZE	MAX DEVIATION FROM NOMINAL VALUE		MAX OVALITY	
	MM	IN	MM	IN
d	Tol = $\pm 0.015 \cdot \sqrt{d}$	(Tol = $\pm 0.002976 \cdot \sqrt{d}$)	Tol $\leq 0.015 \cdot \sqrt{d}$	(Tol $\leq 0.002976 \cdot \sqrt{d}$)

Max ovality = a - b

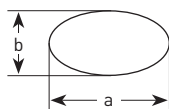

TOLERANCES ON DIMENSIONS OF COLD ROLLED RIBBON

Ribbon is normally specified with a resistance tolerance. If requested, dimension tolerance on width can be applied as below.

WIDTH, MM (IN)	THICKNESS, MM (IN)		
	0.07-0.2 (0.0028-0.008)	0.2-0.5 (0.008-0.020)	0.5-0.8 (0.020-0.031)
0.5-1.5 (0.020-0.059)	+0.02-0.04 (+0.0008-0.0016)	+0.01-0.03 (+0.0004-0.0012)	
1.5-2.5 (0.059-0.098)	+0.04-0.07 (+0.0016-0.0028)	+0.03-0.04 (+0.0012-0.0016)	+0.02-0.04 (+0.0008-0.0016)
2.5-4.0 (0.098-0.157)		± 0.08 (± 0.0031)	+0.12 (+0.0047)

DELIVERY FORMS

In order to avoid transport damage all goods are carefully packed in card board boxes or wooden cases, with suitable internal protection.

RESISTANCE HEATING ALLOYS – KANTHAL®, ALKROTHAL®, NIKROTHAL® AND NIFETHAL™

WIRE

Wire of ≤ 1.63 mm (0.064 in) is delivered on spools, such as shown in the figure. Only one length of wire is wound on each spool.

Wire sizes between 0.40 and 1.63 mm (0.016–0.064 in) can be supplied in round pail packs (drums) such as shown in the table below.

Wire sizes > 1.65 mm (0.065 in) is normally supplied in coils with an inner diameter of approx. 500–600 mm (19.7–23.6 in).

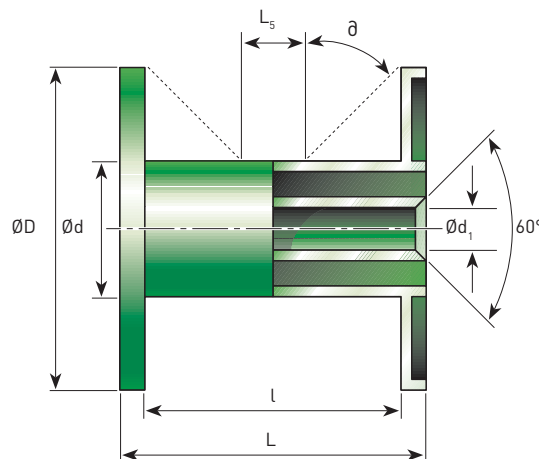

Spool (B 1, B 2, B 4).

TYPES OF WIRE SPOOLS

SPOOL NO.	TARE G (LB)	SPOOL MEASUREMENTS, MM (IN)					WIRE DIAMETER MM (IN)	CAPACITY APPROX. KG (LB)
		D	D	D1	L	L		
B 1	100 (0.22)	75 (2.95)	40 (1.57)	16 (0.63)	120 (4.72)	100 (3.94)	0.10–0.19 (0.004–0.007)	1 (2.2)
B 2	115 (0.25)	90 (3.54)	40 (1.57)	16 (0.63)	120 (4.72)	100 (3.94)	0.20–0.24 (0.008–0.009)	2 (4.4)
B 4	180 (0.40)	120 (4.72)	50 (1.97)	16 (0.63)	120 (4.72)	100 (3.94)	0.25–1.00 (0.010–0.039)	4 (8.8)
DIN 200	600 (1.32)	200 (7.87)	125 (4.92)	36 (1.42)	200 (7.87)	160 (6.30)	0.16–1.20 (0.006–0.047)	10 (22.0)
DIN 250	1050 (2.31)	250 (9.84)	160 (6.30)	36 (1.42)	200 (7.87)	160 (6.30)	0.30–1.63 (0.012–0.064)	20 (44.1)
DIN 355	1850 (4.08)	355 (13.98)	224 (8.82)	36 (1.42)	200 (7.87)	160 (6.30)	0.50–1.63 (0.022–0.064)	40 (88.2)

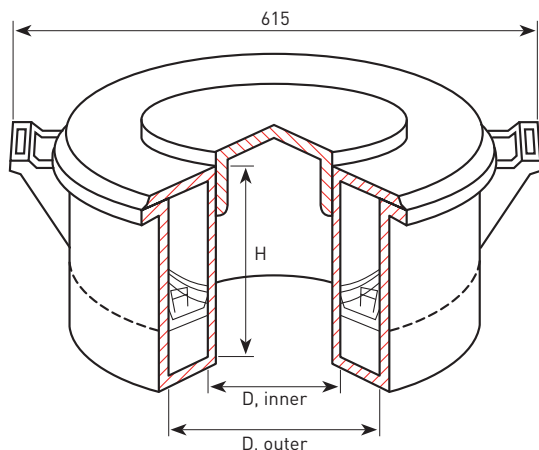

Pail pack.

TYPES OF WIRE PAILS (DRUM PACK)

PAIL NO.	TARE G (LB)	PAIL MEASUREMENTS, MM (IN)			MATERIAL	WIRE DIAMETER MM (IN)	CAPACITY APPROX.	
		D, OUTER	D, INNER	HEIGHT			KG (LB)	
P 50	2600 (5.7)	508 (20.0)	330 (13.0)	150 (5.9)	plastic	0.40-1.63 (0.016-0.064)	33 (73)	
P 100	3500 (7.7)	508 (20.0)	330 (13.0)	250 (9.8)	plastic	0.40-1.63 (0.016-0.064)	50 (110)	
P 200	8500 (18.7)	500 (19.7)	300 (11.8)	520 (20.5)	cardboard	0.80-1.63 (0.031-0.064)	160-240 (352-529)	
P 350	10000 (22.0)	500 (19.7)	300 (11.8)	820 (32.3)	cardboard	0.80-1.63 (0.031-0.064)	250-400 (551-882)	

RIBBON

Ribbon is normally supplied on DIN 125 spools. Sizes of section $\geq 0.3 \text{ mm}^2$ (0.0005 in²) are wound on DIN 100 spools. If requested, the smallest sizes can be supplied on DIN 80 spools.

RODS

Available shaved or unshaved depending on the alloy.

TYPES OF RIBBON SPOOLS

SPOOL NO.	TARE G (LB)	SPOOL MEASUREMENTS, MM (IN)					CAPACITY, KG (LB)	
		D	D	D1	L	L	KANTHAL®	NIKROTHAL®
DIN 80	70 (0.15)	80 (3.15)	50 (1.97)	16 (0.63)	80 (3.15)	64 (2.52)	0.7 (1.5)	0.8 (1.8)
DIN 100	125 (0.28)	100 (3.94)	63 (2.48)	16 (0.63)	100 (3.94)	80 (3.15)	1.5 (3.3)	1.9 (4.2)
DIN 125	200 (0.44)	125 (4.92)	80 (3.15)	16 (0.63)	125 (4.92)	100 (3.94)	3 (6.6)	3.5 (7.7)
DIN 200	600 (1.32)	200 (7.87)	125 (4.92)	36 (1.42)	200 (7.87)	160 (6.30)	12 (26.5)	13 (28.7)

OTHER RESISTANCE ALLOYS – CUPROTHAL®

The wire is normally packed as shown below. Wire and ribbon can also be specially packed to individual requirements. To provide additional protection to the materials, spools are wrapped with plastic film or closed in plastic boxes.

WIRE

Wire \leq 1.63 mm (0.064 in) is available on spools. At the request of the customer, wire can also be supplied in pails.

Wire dimensions from 1.63 to 6.0 mm (0.064 – 0.236 in) are available in coils. The inner diameter of the coil is 500 to 600 mm (19.7 – 23.6 in) depending on the alloy type and the diameter.

RODS

Available as shaved or not shaved depending on the alloy. Wire from 2.00 mm up to 8.0 mm (0.079 – 0.031 in) can be straightened in random or fixed lengths. Straight lengths are supplied in bundles.

TYPES OF SPOOLS FOR CUPROTHAL

SPOOL NO.	TARE G (LB)	SPOOL MEASUREMENTS, MM (IN)					WIRE DIAMETER MM (IN)	NOMINAL WIRE WEIGHT KG (LB)
		D	D1	D2	L	L		
DIN 500	7650 (16.9)	500 (19.7)	315 (12.4)	36 (1.42)	250 (9.84)	189 (7.44)	0.80 – 1.40 (0.031 – 0.05)	90 (198.4)
DIN 355	2380 (5.2)	355 (13.98)	224 (8.8)	36 (1.42)	200 (7.87)	160 (6.30)	0.40 – 1.40 (0.016 – 0.05)	40 (88.2)
DIN 250	1050 (2.3)	250 (9.84)	160 (6.30)	36 (1.42)	200 (7.87)	160 (6.30)	0.25 – 1.00 (0.010 – 0.039)	20 (44.1)
DIN 200	580 (1.3)	200 (7.87)	125 (4.92)	36 (1.42)	200 (7.87)	160 (6.30)	0.25 – 0.80 (0.010 – 0.031)	10 (22.0)
DIN 160	350 (0.77)	160 (6.30)	100 (3.94)	22 (0.87)	160 (2.36)	128 (5.04)	0.20 – 0.80 (0.008 – 0.031)	6 (13.2)
DIN 125	200 (0.44)	125 (4.92)	80 (3.15)	16 (0.63)	125 (4.92)	100 (3.94)	0.15 – 0.80 (0.006 – 0.031)	3 (6.6)
DIN 100	120 (0.26)	100 (3.94)	63 (2.48)	16 (0.63)	100 (3.94)	80 (3.15)	0.127 – 0.25 (0.005 – 0.010)	1.5 (3.3)
DIN 80	60 (0.13)	80 (3.15)	50 (1.97)	16 (0.63)	80 (3.15)	64 (2.52)	0.127 – 0.25 (0.005 – 0.010)	0.5 (1.1)

TABLES

The following tables show metric values for wire and ribbon.

Dimensions and different elements are described more in detail in the handbook for 'Resistance heating alloys and systems for industrial furnaces'.

Sandvik can supply any dimension on request, provided the volume is large enough.



KANTHAL[®] A-1 AND KANTHAL APM[™]

WIRE DIMENSIONS AND PROPERTIES

Resistivity 1.45 Ω mm²/m (872 Ω/cm²). Density 7.10 g/cm³ (0.256 lb/in³).

To obtain resistivity at working temperature, multiply by factor C_t in following table.

°C	20	100	200	300	400	500	600	700	800	900	1000	1100	1200	1300	1400
C _t	1.00	1.00	1.00	1.00	1.00	1.01	1.02	1.02	1.03	1.03	1.04	1.04	1.04	1.04	1.05

DIAMETER, MM		RESISTANCE AT 20°C	SURFACE AREA PER Ω	WEIGHT	SURFACE AREA	CROSS SECTIONAL AREA
KANTHAL [®] A-1	KANTHAL APM [™]	Ω/M	CM ² /Ω*	G/M	CM ² /M	MM ²
10.0	10.0	0.0185	17017	558	314	78.5
9.5	9.5	0.0205	14590	503	298	70.9
	9.27	0.0215	13555	479	291	67.5
8.25	8.25	0.0271	9555	380	259	53.5
8.0	8.0	0.0288	8713	357	251	50.3
7.35	7.35	0.0342	6757	301	231	42.4
7.0	7.0	0.0377	5837	273	220	38.5
6.54		0.0432	4760	239	205	33.6
6.5	6.5	0.0437	4673	236	204	33.2
6.0	6.0	0.0513	3676	201	188	28.3
5.83		0.0543	3372	190	183	26.7
5.5	5.5	0.0610	2831	169	173	23.8
5.0	5.0	0.0738	2127	139	157	19.6
4.75	4.75	0.0818	1824	126	149	17.7
4.62		0.0865	1678	119	145	16.8
4.5	4.5	0.0912	1551	113	141	15.9
4.25	4.25	0.102	1306	101	134	14.2
4.11		0.109	1181	94.2	129	13.3
4.06		0.112	1139	91.9	128	12.9
4.0	4.0	0.115	1089	89.2	126	12.6
3.75	3.75	0.131	897	78.4	118	11.0
3.65		0.139	827	74.3	115	10.5
3.5	3.5	0.151	730	68.3	110	9.62
3.35		0.165	640	62.6	105	8.81
3.25	3.25	0.175	584	58.9	102	8.30
3.2		0.180	558	57.1	101	8.04

* cm²/Ω = I² × C_t / p (I = Current, C_t = temperature factor, p = surface load W/cm²)

[cont.]

[cont.]

DIAMETER, MM		RESISTANCE AT 20°C	SURFACE AREA PER Ω	WEIGHT	SURFACE AREA	CROSS SECTIONAL AREA
KANTHAL® A-1	KANTHAL APM™	Ω/M	CM²/Ω*	G/M	CM²/M	MM²
3.0	3.0	0.205	459	50.2	94.2	7.07
2.95		0.212	437	48.5	92.7	6.83
2.9	2.9	0.220	415	46.9	91.1	6.61
2.8	2.8	0.235	374	43.7	88.0	6.16
2.65		0.263	317	39.2	83.3	5.52
2.6	2.6	0.273	299	37.7	81.7	5.31
2.5	2.5	0.295	266	34.9	78.5	4.91
2.4		0.321	235	32.1	75.4	4.52
2.34		0.337	218	30.5	73.5	4.30
2.3	2.3	0.349	207	29.5	72.3	4.15
2.25		0.365	194	28.2	70.7	3.98
2.2	2.2	0.381	181	27.0	69.1	3.80
2.05		0.439	147	23.4	64.4	3.30
2.03		0.448	142	23.0	63.8	3.24
2.0	2.0	0.462	136	22.3	62.8	3.14
1.83		0.551	104	18.7	57.5	2.63
1.8	1.8	0.570	99	18.1	56.5	2.54
1.7	1.7	0.639	83.6	16.1	53.4	2.27
1.6		0.695	73.7	14.8	51.2	2.09
1.6		0.721	69.7	14.3	50.3	2.01
1.5	1.5	0.821	57.4	12.5	47.1	1.77
1.4		0.942	46.7	10.9	44.0	1.54
1.3		1.09	37.4	9.42	40.8	1.33
1.2	1.2	1.28	29.4	8.03	37.7	1.13
1.1		1.53	22.6	6.75	34.6	0.950
1.0	1.0	1.85	17.0	5.58	31.4	0.785

* $\text{cm}^2/\Omega = I^2 \times C_t / p$ (I = Current, C_t = temperature factor, p = surface load W/cm²)

KANTHAL A[®], KANTHAL AF AND KANTHAL AE

WIRE DIMENSIONS AND PROPERTIES

Resistivity 1.39 Ω mm²/m (836 Ω /cmf). Density 7.15 g/cm³ (0.258 lb/in³).

To obtain resistivity at working temperature, multiply by factor C_t in following table.

°C	20	100	200	300	400	500	600	700	800	900	1000	1100	1200	1300
C_t	1.00	1.00	1.01	1.01	1.02	1.03	1.04	1.04	1.05	1.05	1.06	1.06	1.06	1.06

DIAMETER, MM		RESISTANCE AT 20°C	SURFACE AREA PER Ω	WEIGHT	SURFACE AREA	CROSS SECTIONAL AREA
KANTHAL [®] A	KANTHAL AF	Ω /M	CM ² / Ω *	G/M	CM ² /M	MM ²
10.0	10.0	0.0177	17751	562	314	78.0
	8.25	0.0260	9968	382	259	53.5
	8.0	0.0277	9089	359	251	50.3
	7.5	0.0315	7489	316	236	44.2
	7.35	0.0328	7048	303	231	42.4
	7.0	0.0361	6089	275	220	38.5
	6.54	0.0414	4965	240	205	33.6
	6.5	0.0419	4875	237	204	33.2
	6.0	0.0492	3834	202	188	28.3
	5.83	0.0521	3517	191	183	26.7
	5.5	0.0585	2953	170	173	23.8
	5.2	0.0655	2496	152	163	21.2
	5.0	0.0708	2219	140	157	19.6
	4.75	0.0784	1902	127	149	17.7
	4.62	0.0829	1750	120	145	16.8
	4.5	0.0874	1618	114	141	15.9
	4.25	0.0980	1363	101	134	14.2
	4.11	0.105	1232	94.9	129	13.3
	4.0	0.111	1136	89.8	126	12.6
	3.75	0.126	936	79.0	118	11.0
	3.65	0.133	863	74.8	115	10.5
	3.5	0.144	761	68.8	110	9.62
	3.25	0.168	609	59.3	102	8.30
	3.2	0.173	582	57.5	101	8.04
	3.0	0.197	479	50.5	94.2	7.07
	2.9	0.210	433	47.2	91.1	6.61
	2.8	0.226	390	44.0	88.0	6.16
	2.6	0.262	312	38.0	81.7	5.31
	2.5	0.283	277	35.1	78.5	4.91
	2.4	0.307	245	32.3	75.4	4.52
	2.3	0.335	216	29.7	72.3	4.15

* $cm^2/\Omega = I^2 \times C_t / p$ (I = Current, C_t = temperature factor, p = surface load W/cm²)

(cont.)

[cont.]

DIAMETER, MM		RESISTANCE AT 20°C Ω/M	SURFACE AREA PER Ω CM ² /Ω*	WEIGHT G/M	SURFACE AREA CM ² /M	CROSS SECTIONAL AREA MM ²
KANTHAL® A	KANTHAL AF					
	2.25	0.350	202	28.4	70.7	3.98
	2.2	0.366	189	27.2	69.1	3.80
	2.0	0.442	142	22.5	62.8	3.14
	1.8	0.546	104	18.2	56.5	2.54
	1.7	0.612	87.2	16.2	53.4	2.27
	1.65	0.650	79.7	15.3	51.8	2.14
	1.6	0.691	72.7	14.4	50.3	2.01
	1.5	0.787	59.9	12.6	47.1	1.77
	1.4	0.903	48.7	11.0	44.0	1.54
	1.3	1.05	39.0	9.49	40.8	1.33
	1.2	1.23	30.7	8.09	37.7	1.13
	1.1	1.46	23.6	6.79	34.6	0.950
	1.0	1.77	17.8	5.62	31.4	0.785
	0.95	1.96	15.2	5.07	29.8	0.709
0.90	0.90	2.18	12.9	4.55	28.3	0.636
0.85	0.85	2.45	10.9	4.06	26.7	0.567
0.80	0.80	2.77	9.09	3.59	25.1	0.503
0.75	0.75	3.15	7.49	3.16	23.6	0.442
0.70	0.70	3.61	6.09	2.75	22.0	0.385
0.65	0.65	4.19	4.87	2.37	20.4	0.332
0.60	0.60	4.92	3.83	2.02	18.8	0.283
0.55	0.55	5.85	2.95	1.70	17.3	0.238
0.50	0.50	7.08	2.22	1.40	15.7	0.196
0.45	0.45	8.74	1.62	1.14	14.1	0.159
0.40	0.40	11.1	1.14	0.898	12.6	0.126
0.35	0.35	14.4	0.761	0.688	11.0	0.0962
0.30	0.30	19.7	0.479	0.505	9.42	0.0707
0.25		28.3	0.277	0.351	7.85	0.0491
0.20		44.2	0.142	0.225	6.28	0.0314
0.15		78.7	0.060	0.126	4.71	0.0177

* $\text{cm}^2/\Omega = I^2 \times C_t / p$ (I = Current, C_t = temperature factor, p = surface load W/cm²)

KANTHAL A[®], KANTHAL AF AND KANTHAL AE

RIBBON DIMENSIONS AND PROPERTIES

Resistivity 1.39 Ω mm²/m (836 Ω /cmf). Density 7.15 g/cm³ (0.258 lb/in³).

To obtain resistance at working temperature, multiply by the factor C_t in the following table.

°C	20	100	200	300	400	500	600	700	800	900	1000	1100	1200	1300
C_t	1.00	1.00	1.01	1.01	1.02	1.03	1.04	1.04	1.05	1.05	1.06	1.06	1.06	1.06

WIDTH MM	THICKNESS MM	RESISTANCE AT 20°C Ω /M	SURFACE AREA PER Ω CM ² / Ω *	WEIGHT G/M	SURFACE AREA CM ² /M	CROSS SECTIONAL AREA MM ²
4	0.50	0.755	119	13.2	90.0	1.84
	0.40	0.944	93.2	10.5	88.0	1.47
	0.30	1.26	68.3	7.89	86.0	1.10
	0.20	1.89	44.5	5.26	84.0	0.736
	0.15	2.52	33.0	3.95	83.0	0.552
	0.10	3.78	21.7	2.63	82.0	0.368
3	1.0	0.504	159	19.7	80.0	2.76
	0.90	0.560	139	17.8	78.0	2.48
	0.80	0.630	121	15.8	76.0	2.21
	0.70	0.719	103	13.8	74.0	1.93
	0.60	0.839	85.8	11.8	72.0	1.66
	0.50	1.01	69.5	9.87	70.0	1.38
	0.40	1.26	54.0	7.89	68.0	1.10
	0.30	1.68	39.3	5.92	66.0	0.828
	0.20	2.52	25.4	3.95	64.0	0.552
	0.15	3.36	18.8	2.96	63.0	0.414
2.5	1.0	0.604	116	16.4	70.0	2.30
	0.90	0.671	101	14.8	68.0	2.07
	0.80	0.755	87.4	13.2	66.0	1.84
	0.70	0.863	74.1	11.5	64.0	1.61
	0.60	1.01	61.6	9.87	62.0	1.38
	0.50	1.21	49.6	8.22	60.0	1.15
	0.40	1.51	38.4	6.58	58.0	0.920
	0.30	2.01	27.8	4.93	56.0	0.690
	0.20	3.02	17.9	3.29	54.0	0.460
	0.15	4.03	13.2	2.47	53.0	0.345
2.0	1.0	0.604	116	16.4	70.0	2.30
	0.80	0.944	59.3	10.5	56.0	1.47
	0.70	1.08	50.0	9.21	54.0	1.29
	0.60	1.26	41.3	7.89	52.0	1.10
	0.50	1.51	33.1	6.58	50.0	0.920

* $\text{cm}^2/\Omega = I^2 \times C_t / p$ (I = Current, C_t = temperature factor, p = surface load W/cm²)

(cont.)

[cont.]

WIDTH MM	THICKNESS MM	RESISTANCE AT 20°C Ω/M	SURFACE AREA PER Ω CM ² /Ω*	WEIGHT G/M	SURFACE AREA CM ² /M	CROSS SECTIONAL AREA MM ²
2.0	0.40	1.89	25.4	5.26	48.0	0.736
	0.30	2.52	18.3	3.95	46.0	0.552
	0.20	3.78	11.6	2.63	44.0	0.368
	0.15	5.04	8.54	1.97	43.0	0.276
	0.10	7.55	5.56	1.32	42.0	0.184
1.8	0.80	1.05	49.6	9.47	52.0	1.32
	0.70	1.20	41.7	8.29	50.0	1.16
	0.60	1.40	34.3	7.10	48.0	0.994
	0.50	1.68	27.4	5.92	46.0	0.828
	0.40	2.10	21.0	4.74	44.0	0.662
	0.30	2.80	15.0	3.55	42.0	0.497
	0.20	4.20	9.53	2.37	40.0	0.331
	0.15	5.60	6.97	1.78	39.0	0.248
1.5	0.10	8.39	4.53	1.18	38.0	0.166
	0.80	1.26	36.5	7.89	46.0	1.10
	0.70	1.44	30.6	6.91	44.0	0.966
	0.60	1.68	25.0	5.92	42.0	0.828
	0.50	2.01	19.9	4.93	40.0	0.690
	0.40	2.52	15.1	3.95	38.0	0.552
	0.30	3.36	10.7	2.96	36.0	0.414
	0.20	5.04	6.75	1.97	34.0	0.276
	0.15	6.71	4.91	1.48	33.0	0.207
	0.10	10.1	3.18	0.987	32.0	0.138
1.2	0.090	11.2	2.84	0.888	31.8	0.124
	0.080	12.6	2.51	0.789	31.6	0.110
	0.80	1.57	25.4	6.31	40.0	0.883
	0.70	1.80	21.1	5.53	38.0	0.773
	0.60	2.10	17.2	4.74	36.0	0.662
	0.50	2.52	13.5	3.95	34.0	0.552
	0.40	3.15	10.2	3.16	32.0	0.442
	0.30	4.20	7.15	2.37	30.0	0.331
	0.20	6.30	4.45	1.58	28.0	0.221

* $\text{cm}^2/\Omega = I^2 \times C_t / p$ (I = Current, C_t = temperature factor, p = surface load W/cm²)

[cont.]

KANTHAL® A, KANTHAL AF AND KANTHAL AE RIBBON DIMENSIONS AND PROPERTIES

[cont.]

WIDTH MM	THICKNESS MM	RESISTANCE AT 20°C Ω/M	SURFACE AREA PER Ω CM ² /Ω*	WEIGHT G/M	SURFACE AREA CM ² /M	CROSS SECTIONAL AREA MM ²
1.2	0.15	8.39	3.22	1.18	27.0	0.166
	0.10	12.6	2.07	0.789	26.0	0.110
	0.090	14.0	1.84	0.710	25.8	0.0994
	0.080	15.7	1.63	0.631	25.6	0.0883
1.0	0.60	2.52	12.7	3.95	32.0	0.552
	0.50	3.02	9.93	3.29	30.0	0.460
	0.40	3.78	7.41	2.63	28.0	0.368
	0.30	5.04	5.16	1.97	26.0	0.276
	0.20	7.55	3.18	1.32	24.0	0.184
	0.15	10.1	2.28	0.987	23.0	0.138
	0.10	15.1	1.46	0.658	22.0	0.0920
	0.090	16.8	1.30	0.592	21.8	0.0828
0.9	0.080	18.9	1.14	0.526	21.6	0.0736
	0.50	3.36	8.34	2.96	28.0	0.414
	0.40	4.20	6.20	2.37	26.0	0.331
	0.30	5.60	4.29	1.78	24.0	0.248
	0.20	8.39	2.62	1.18	22.0	0.166
	0.15	11.2	1.88	0.888	21.0	0.124
	0.10	16.8	1.19	0.592	20.0	0.0828
	0.090	18.7	1.06	0.533	19.8	0.0745
	0.080	21.0	0.934	0.474	19.6	0.0662
	0.070	24.0	0.809	0.414	19.4	0.0580
0.8	0.060	28.0	0.686	0.355	19.2	0.0497
	0.050	33.6	0.566	0.296	19.0	0.0414
	0.40	4.72	5.08	2.10	24.0	0.294
	0.30	6.30	3.49	1.58	22.0	0.221
	0.20	9.44	2.12	1.05	20.0	0.147
	0.15	12.6	1.51	0.789	19.0	0.110
	0.10	18.9	0.953	0.526	18.0	0.0736
	0.090	21.0	0.848	0.474	17.8	0.0662
0.7	0.080	23.6	0.746	0.421	17.6	0.0589
	0.070	27.0	0.645	0.368	17.4	0.0515
	0.30	7.19	2.78	1.38	20.0	0.193
	0.20	10.8	1.67	0.921	18.0	0.129
	0.15	14.4	1.18	0.691	17.0	0.097
	0.10	21.6	0.741	0.460	16.0	0.0644

* $\text{cm}^2/\Omega = I^2 \times C_t / p$ (I = Current, C_t = temperature factor, p = surface load W/cm²)

[cont.]

(cont.)

WIDTH MM	THICKNESS MM	RESISTANCE AT 20°C Ω/M	SURFACE AREA PER Ω CM ² /Ω*	WEIGHT G/M	SURFACE AREA CM ² /M	CROSS SECTIONAL AREA MM ²	
0.7	0.090	24.0	0.659	0.414	15.8	0.0580	
	0.080	27.0	0.578	0.368	15.6	0.0515	
	0.070	30.8	0.499	0.322	15.4	0.0451	
	0.060	36.0	0.423	0.276	15.2	0.0386	
0.6	0.30	8.4	2.14	1.18	18.0	0.166	
	0.20	12.6	1.27	0.789	16.0	0.110	
	0.15	16.8	0.894	0.592	15.0	0.0828	
	0.10	25.2	0.556	0.395	14.0	0.0552	
	0.090	28.0	0.493	0.355	13.8	0.0497	
	0.080	31.5	0.432	0.316	13.6	0.0442	
	0.070	36.0	0.373	0.276	13.4	0.0386	
	0.060	42.0	0.315	0.237	13.2	0.0331	
	0.050	50.4	0.258	0.197	13.0	0.0276	
	0.5	0.30	10.1	1.59	0.987	16.0	0.138
0.20		15.1	0.927	0.658	14.0	0.0920	
0.15		20.1	0.645	0.493	13.0	0.0690	
0.10		30.2	0.397	0.329	12.0	0.0460	
0.090		33.6	0.351	0.296	11.8	0.0414	
0.080		37.8	0.307	0.263	11.6	0.0368	
0.070		43.2	0.264	0.230	11.4	0.0322	
0.060		50.4	0.222	0.197	11.2	0.0276	
0.050		60.4	0.182	0.164	11.0	0.0230	
0.4		0.20	18.9	0.635	0.526	12.0	0.0736
	0.15	25.2	0.437	0.395	11.0	0.0552	
	0.10	37.8	0.265	0.263	10.0	0.0368	
	0.090	42.0	0.234	0.237	9.80	0.0331	
	0.080	47.2	0.203	0.210	9.60	0.0294	
	0.070	54.0	0.174	0.184	9.40	0.0258	
	0.060	63.0	0.146	0.158	9.20	0.0221	
	0.050	75.5	0.119	0.132	9.00	0.0184	
	0.3	0.15	33.6	0.268	0.296	9.00	0.0414
		0.10	50.4	0.159	0.197	8.00	0.0276
0.090		56.0	0.139	0.178	7.80	0.0248	
0.080		63.0	0.121	0.158	7.60	0.0221	
0.070		71.9	0.103	0.138	7.40	0.0193	
0.060		83.9	0.0858	0.118	7.20	0.0166	

* $\text{cm}^2/\Omega = I^2 \times C_t / \rho$ (I = Current, C_t = temperature factor, ρ = surface load W/cm²)

KANTHAL® D

WIRE DIMENSIONS AND PROPERTIES

Resistivity 1.35 Ω mm²/m (812 Ω /cmf). Density 7.25 g/cm³ (0.262 lb/in³).

To obtain resistivity at working temperature, multiply by factor C_t in following table.

°C	20	100	200	300	400	500	600	700	800	900	1000	1100	1200	1300
C_t	1.00	1.00	1.01	1.01	1.02	1.03	1.04	1.05	1.06	1.07	1.07	1.07	1.08	1.08

DIAMETER	RESISTANCE	RESISTIVITY	WEIGHT	SURFACE AREA	CROSS
MM	AT 20°C	AT 20°C	G/M	CM ² /M	SECTIONAL AREA
	Ω /M	CM ² / Ω *			MM ²
8.0	0.0269	9358	364	251	50.3
6.5	0.0407	5019	241	204	33.2
6.0	0.0477	3948	205	188	28.3
5.5	0.0568	3041	172	173	23.8
5.0	0.0688	2285	142	157	19.6
4.75	0.0762	1959	128	149	17.7
4.5	0.0849	1666	115	141	15.9
4.25	0.0952	1403	103	134	14.2
4.06	0.104	1223	93.9	128	12.9
4.0	0.107	1170	91.1	126	12.6
3.75	0.122	964	80.1	118	11.0
3.65	0.129	889	75.9	115	10.5
3.5	0.140	784	69.8	110	9.62
3.25	0.163	627	60.1	102	8.30
3.0	0.191	493	51.2	94.2	7.07
2.95	0.198	469	49.6	92.7	6.8
2.8	0.219	401	44.6	88.0	6.16
2.65	0.245	340	40.0	83.3	5.5
2.5	0.275	286	35.6	78.5	4.91
2.0	0.430	146	22.8	62.8	3.14
1.8	0.531	107	18.4	56.5	2.54
1.7	0.595	89.8	16.5	53.4	2.27
1.6	0.671	74.9	14.6	50.3	2.01
1.5	0.764	61.7	12.8	47.1	1.77
1.4	0.877	50.2	11.2	44.0	1.54
1.3	1.02	40.2	9.62	40.8	1.33
1.2	1.19	31.6	8.20	37.7	1.13
1.1	1.42	24.3	6.89	34.6	0.950

* $\text{cm}^2/\Omega = I^2 \times C_t / \rho$ (I = Current, C_t = temperature factor, ρ = surface load W/cm²)

(cont.)

[cont.]

DIAMETER MM	RESISTANCE AT 20°C Ω/M	RESISTIVITY AT 20°C CM ² /Ω*	WEIGHT G/M	SURFACE AREA CM ² /M	CROSS SECTIONAL AREA MM ²
1.0	1.72	18.3	5.69	31.4	0.785
0.95	1.90	15.7	5.14	29.8	0.709
0.90	2.12	13.3	4.61	28.3	0.636
0.85	2.38	11.2	4.11	26.7	0.567
0.80	2.69	9.36	3.64	25.1	0.503
0.75	3.06	7.71	3.20	23.6	0.442
0.70	3.51	6.27	2.79	22.0	0.385
0.65	4.07	5.02	2.41	20.4	0.332
0.60	4.77	3.95	2.05	18.8	0.283
0.55	5.68	3.04	1.72	17.3	0.238
0.50	6.88	2.28	1.42	15.7	0.196
0.45	8.49	1.67	1.15	14.1	0.159
0.42	9.74	1.35	1.00	13.2	0.139
0.40	10.7	1.17	0.911	12.6	0.126
0.35	14.0	0.784	0.698	11.0	0.0962
0.32	16.8	0.599	0.583	10.1	0.0804
0.30	19.1	0.493	0.512	9.42	0.0707
0.28	21.9	0.401	0.446	8.80	0.061
0.25	27.5	0.286	0.356	7.85	0.0491
0.22	35.5	0.195	0.276	6.91	0.0380
0.20	43.0	0.146	0.228	6.28	0.0314
0.19	47.6	0.125	0.206	5.97	0.0284
0.18	53.1	0.107	0.184	5.65	0.0254
0.17	59.5	0.0898	0.165	5.34	0.0227
0.16	67.1	0.0749	0.146	5.03	0.0201
0.15	76.4	0.0617	0.128	4.71	0.0177
0.14	87.7	0.0502	0.112	4.40	0.0154
0.13	102	0.0402	0.0962	4.08	0.0133

* $\text{cm}^2/\Omega = I^2 \times C_t / \rho$ (I = Current, C_t = temperature factor, ρ = surface load W/cm²)

KANTHAL® D

RIBBON DIMENSIONS AND PROPERTIES

Resistivity 1.39 Ω mm²/m (836 Ω /cmf). Density 7.25 g/cm³ (0.262 lb/in³).

To obtain resistance at working temperature, multiply by the factor C_t in the following table.

°C	20	100	200	300	400	500	600	700	800	900	1000	1100	1200	1300
C_t	1.00	1.00	1.01	1.01	1.02	1.03	1.04	1.05	1.06	1.07	1.07	1.07	1.08	1.08

WIDTH MM	THICKNESS MM	RESISTANCE AT 20°C Ω /M	SURFACE AREA PER Ω CM ² / Ω *	WEIGHT G/M	SURFACE AREA CM ² /M	CROSS SECTIONAL AREA MM ²
4	0.50	0.734	123	13.3	90.0	1.84
	0.40	0.917	96.0	10.7	88.0	1.47
	0.30	1.22	70.3	8.00	86.0	1.10
	0.20	1.83	45.8	5.34	84.0	0.736
	0.15	2.45	33.9	4.00	83.0	0.552
	0.10	3.67	22.4	2.67	82.0	0.368
3	1.0	0.489	164	20.0	80.0	2.76
	0.90	0.543	144	18.0	78.0	2.48
	0.80	0.611	124	16.0	76.0	2.21
	0.70	0.699	106	14.0	74.0	1.93
	0.60	0.815	88.3	12.0	72.0	1.66
	0.50	0.978	71.6	10.0	70.0	1.38
	0.40	1.22	55.6	8.0	68.0	1.10
	0.30	1.63	40.5	6.0	66.0	0.828
	0.20	2.45	26.2	4.0	64.0	0.552
	0.15	3.26	19.3	3.0	63.0	0.414
2.5	1.0	0.587	119	16.7	70.0	2.30
	0.90	0.652	104	15.0	68.0	2.07
	0.80	0.734	90.0	13.3	66.0	1.84
	0.70	0.839	76.3	11.7	64.0	1.61
	0.60	0.978	63.4	10.0	62.0	1.38
	0.50	1.17	51.1	8.34	60.0	1.15
	0.40	1.47	39.5	6.67	58.0	0.920
	0.30	1.96	28.6	5.00	56.0	0.690
	0.20	2.93	18.4	3.34	54.0	0.460
	0.15	3.91	13.5	2.50	53.0	0.345
2.25	1.0	0.652	99.7	15.0	65.0	2.07
	0.90	0.725	86.9	13.5	63.0	1.86
	0.80	0.815	74.8	12.0	61.0	1.66
	0.70	0.932	63.3	10.5	59.0	1.45
	0.60	1.09	52.4	9.00	57.0	1.24
	0.50	1.30	42.2	7.50	55.0	1.04
	0.40	1.63	32.5	6.00	53.0	0.828
	0.30	2.17	23.5	4.50	51.0	0.621

* $\text{cm}^2/\Omega = I^2 \times C_t / p$ (I = Current, C_t = temperature factor, p = surface load W/cm²)

(cont.)

[cont.]

WIDTH MM	THICKNESS MM	RESISTANCE AT 20°C Ω/M	SURFACE AREA PER Ω CM ² /Ω*	WEIGHT G/M	SURFACE AREA CM ² /M	CROSS SECTIONAL AREA MM ²
2.25	0.20	3.26	15.0	3.00	49.0	0.414
	0.15	4.35	11.0	2.25	48.0	0.311
	0.10	6.52	7.21	1.50	47.0	0.207
2.0	0.80	0.917	61.1	10.7	56.0	1.47
	0.70	1.05	51.5	9.34	54.0	1.29
	0.60	1.22	42.5	8.00	52.0	1.10
	0.50	1.47	34.1	6.67	50.0	0.920
	0.40	1.83	26.2	5.34	48.0	0.736
	0.30	2.45	18.8	4.00	46.0	0.552
	0.20	3.67	12.0	2.67	44.0	0.368
	0.15	4.89	8.79	2.00	43.0	0.276
	0.10	7.34	5.72	1.33	42.0	0.184
1.75	1.0	0.839	65.6	11.7	55.0	1.61
	0.90	0.932	56.9	10.5	53.0	1.45
	0.80	1.05	48.7	9.34	51.0	1.29
	0.70	1.20	40.9	8.17	49.0	1.13
	0.60	1.40	33.6	7.00	47.0	0.966
	0.50	1.68	26.8	5.84	45.0	0.805
	0.40	2.10	20.5	4.67	43.0	0.644
	0.30	2.80	14.7	3.50	41.0	0.483
	0.20	4.19	9.30	2.33	39.0	0.322
	0.15	5.59	6.80	1.75	38.0	0.242
1.5	0.10	8.39	4.41	1.17	37.0	0.161
	0.70	1.40	31.5	7.00	44.0	0.966
	0.60	1.63	25.8	6.00	42.0	0.828
	0.50	1.96	20.4	5.00	40.0	0.690
	0.40	2.45	15.5	4.00	38.0	0.552
	0.30	3.26	11.0	3.00	36.0	0.414
	0.50	2.52	13.5	3.95	34.0	0.552
	0.40	3.15	10.2	3.16	32.0	0.442
	0.30	4.20	7.15	2.37	30.0	0.331
	0.20	6.30	4.45	1.58	28.0	0.221
	0.20	4.89	6.95	2.00	34.0	0.276
	0.15	6.52	5.06	1.50	33.0	0.207
	0.10	9.78	3.27	1.00	32.0	0.138
0.090	10.9	2.93	0.900	31.8	0.124	

* $\text{cm}^2/\Omega = I^2 \times C_t / p$ (I = Current, C_t = temperature factor, p = surface load W/cm^2)

[cont.]

KANTHAL® D RIBBON DIMENSIONS AND PROPERTIES

(cont.)

WIDTH MM	THICKNESS MM	RESISTANCE AT 20°C Ω/M	SURFACE AREA PER Ω CM ² /Ω*	WEIGHT G/M	SURFACE AREA CM ² /M	CROSS SECTIONAL AREA MM ²
1.5	0.080	12.2	2.58	0.800	31.6	0.110
1.25	0.60	1.96	18.9	5.00	37.0	0.690
	0.50	2.35	14.9	4.17	35.0	0.575
	0.40	2.93	11.2	3.34	33.0	0.460
	0.30	3.91	7.92	2.50	31.0	0.345
	0.20	5.87	4.94	1.67	29.0	0.230
	0.15	7.83	3.58	1.25	28.0	0.173
	0.10	11.7	2.30	0.834	27.0	0.115
	0.090	13.0	2.05	0.750	26.8	0.104
	0.080	14.7	1.81	0.667	26.6	0.0920
	0.070	16.8	1.57	0.584	26.4	0.0805
1.0	0.60	2.45	13.1	4.00	32.0	0.552
	0.50	2.93	10.2	3.34	30.0	0.460
	0.40	3.67	7.63	2.67	28.0	0.368
	0.30	4.89	5.32	2.00	26.0	0.276
	0.20	7.34	3.27	1.33	24.0	0.184
	0.15	9.78	2.35	1.00	23.0	0.138
	0.10	14.7	1.50	0.667	22.0	0.0920
	0.090	16.3	1.34	0.600	21.8	0.0828
	0.080	18.3	1.18	0.534	21.6	0.0736
0.9	0.50	3.26	8.59	3.00	28.0	0.414
	0.40	4.08	6.38	2.40	26.0	0.331
	0.30	5.43	4.42	1.80	24.0	0.248
	0.20	8.15	2.70	1.20	22.0	0.166
	0.15	10.9	1.93	0.900	21.0	0.124
	0.10	16.3	1.23	0.600	20.0	0.0828
	0.090	18.1	1.09	0.540	19.8	0.0745
	0.080	20.4	0.962	0.480	19.6	0.0662
	0.070	23.3	0.833	0.420	19.4	0.0580
	0.060	27.2	0.707	0.360	19.2	0.0497
	0.050	32.6	0.583	0.300	19.0	0.0414
0.8	0.50	3.67	7.09	2.67	26.0	0.368
	0.40	4.59	5.23	2.13	24.0	0.294
	0.30	6.11	3.60	1.60	22.0	0.221
	0.20	9.17	2.18	1.07	20.0	0.147
	0.15	12.2	1.55	0.800	19.0	0.110
	0.10	18.3	0.981	0.534	18.0	0.0736
	0.090	20.4	0.873	0.480	17.8	0.0662
	0.080	22.9	0.768	0.427	17.6	0.0589
	0.070	26.2	0.664	0.374	17.4	0.0515
0.7	0.40	5.24	4.20	1.87	22.0	0.258
	0.30	6.99	2.86	1.40	20.0	0.193

* $\text{cm}^2/\Omega = I^2 \times C_t / p$ (I = Current, C_t = temperature factor, p = surface load W/cm²)

(cont.)

(cont.)

WIDTH MM	THICKNESS MM	RESISTANCE AT 20°C Ω/M	SURFACE AREA PER Ω CM ² /Ω*	WEIGHT G/M	SURFACE AREA CM ² /M	CROSS SECTIONAL AREA MM ²
0.7	0.20	10.5	1.72	0.934	18.0	0.129
	0.15	14.0	1.22	0.700	17.0	0.097
	0.10	21.0	0.763	0.467	16.0	0.0644
	0.090	23.3	0.678	0.420	15.8	0.0580
	0.080	26.2	0.595	0.374	15.6	0.0515
	0.070	29.9	0.514	0.327	15.4	0.0451
	0.060	34.9	0.435	0.280	15.2	0.0386
0.6	0.30	8.15	2.21	1.20	18.0	0.166
	0.20	12.2	1.31	0.800	16.0	0.110
	0.15	16.3	0.920	0.600	15.0	0.0828
	0.10	24.5	0.572	0.400	14.0	0.0552
	0.090	27.2	0.508	0.360	13.8	0.0497
	0.080	30.6	0.445	0.320	13.6	0.0442
	0.070	34.9	0.384	0.280	13.4	0.0386
	0.060	40.8	0.324	0.240	13.2	0.0331
	0.050	48.9	0.266	0.200	13.0	0.0276
0.5	0.30	9.78	1.64	1.00	16.0	0.138
	0.20	14.7	0.954	0.667	14.0	0.0920
	0.15	19.6	0.664	0.500	13.0	0.0690
	0.10	29.3	0.409	0.334	12.0	0.0460
	0.090	32.6	0.362	0.300	11.8	0.0414
	0.080	36.7	0.316	0.267	11.6	0.0368
	0.070	41.9	0.272	0.233	11.4	0.0322
	0.060	48.9	0.229	0.200	11.2	0.0276
	0.050	58.7	0.187	0.167	11.0	0.0230
0.4	0.20	18.3	0.654	0.534	12.0	0.0736
	0.15	24.5	0.450	0.400	11.0	0.0552
	0.10	36.7	0.273	0.267	10.0	0.0368
	0.090	40.8	0.240	0.240	9.80	0.0331
	0.080	45.9	0.209	0.213	9.60	0.0294
	0.070	52.4	0.179	0.187	9.40	0.0258
	0.060	61.1	0.150	0.160	9.20	0.0221
	0.050	73.4	0.123	0.133	9.00	0.0184
0.3	0.15	32.6	0.276	0.300	9.00	0.0414
	0.10	48.9	0.164	0.200	8.00	0.0276
	0.090	54.3	0.144	0.180	7.80	0.0248
	0.080	61.1	0.124	0.160	7.60	0.0221
	0.070	69.9	0.106	0.140	7.40	0.0193
	0.060	81.5	0.0883	0.120	7.20	0.0166

* $\text{cm}^2/\Omega = I^2 \times C_t / p$ (I = Current, C_t = temperature factor, p = surface load W/cm²)

ALKROTHAL™

WIRE DIMENSIONS AND PROPERTIES

Resistivity 1.25 Ω mm²/m (744 Ω /cmf). Density 7.28 g/cm³ (0.263 lb/in³).

To obtain resistivity at working temperature, multiply by factor C_t in following table.

°C	20	100	200	300	400	500	600	700	800	900	1000	1100
C_t	1.00	1.00	1.02	1.03	1.04	1.05	1.08	1.09	1.10	1.11	1.11	1.12

DIAMETER MM	RESISTANCE AT 20°C Ω /M	RESISTIVITY AT 20°C CM^2/Ω^*	WEIGHT G/M	SURFACE AREA CM^2/M	CROSS SECTIONAL AREA MM^2
6.5	0.0377	5421	242	204	33.2
6.0	0.0442	4264	206	188	28.3
5.5	0.0526	3284	173	173	23.8
5.0	0.0637	2467	143	157	19.6
4.75	0.0705	2115	129	149	17.7
4.5	0.0786	1799	116	141	15.9
4.25	0.0881	1515	103	134	14.2
4.0	0.0995	1263	91.5	126	12.6
3.75	0.113	1041	80.4	118	11.0
3.5	0.130	846	70.0	110	9.62
3.25	0.151	678	60.4	102	8.30
3.0	0.177	533	51.5	94.2	7.07
2.8	0.203	433	44.8	88.0	6.16
2.6	0.235	347	38.7	81.7	5.31
2.5	0.255	308	35.7	78.5	4.91
2.2	0.329	210	27.7	69.1	3.80
2.0	0.398	158	22.9	62.8	3.14
1.9	0.441	135	20.6	59.7	2.84
1.8	0.491	115	18.5	56.5	2.54
1.7	0.551	97.0	16.5	53.4	2.27
1.6	0.622	80.9	14.6	50.3	2.01
1.5	0.707	66.6	12.9	47.1	1.77
1.4	0.812	54.2	11.2	44.0	1.54
1.3	0.942	43.4	9.66	40.8	1.33
1.2	1.11	34.1	8.23	37.7	1.13
1.1	1.32	26.3	6.92	34.6	0.95
1.0	1.59	19.7	5.72	31.4	0.785
0.95	1.76	16.9	5.16	29.8	0.709
0.90	1.96	14.4	4.63	28.3	0.636
0.85	2.20	12.1	4.13	26.7	0.567

* $cm^2/\Omega = I^2 \times C_t / \rho$ (I = Current, C_t = temperature factor, ρ = surface load W/cm²)

[cont.]

[cont.]

DIAMETER MM	RESISTANCE AT 20°C Ω/M	RESISTIVITY AT 20°C CM ² /Ω*	WEIGHT G/M	SURFACE AREA CM ² /M	CROSS SECTIONAL AREA MM ²
0.80	2.49	10.1	3.66	25.1	0.503
0.75	2.83	8.33	3.22	23.6	0.442
0.70	3.25	6.77	2.80	22.0	0.385
0.65	3.77	5.42	2.42	20.4	0.332
0.60	4.42	4.26	2.06	18.8	0.283
0.55	5.26	3.28	1.73	17.3	0.238
0.50	6.37	2.47	1.43	15.7	0.196
0.475	7.05	2.12	1.29	14.9	0.177
0.45	7.86	1.80	1.16	14.1	0.159
0.425	8.81	1.52	1.03	13.4	0.142
0.40	9.95	1.26	0.915	12.6	0.126
0.375	11.3	1.04	0.804	11.8	0.110
0.35	13.0	0.846	0.700	11.0	0.0962
0.32	15.5	0.647	0.585	10.1	0.0804
0.30	17.7	0.533	0.515	9.42	0.0707
0.28	20.3	0.433	0.448	8.80	0.0616
0.26	23.5	0.347	0.387	8.17	0.0531
0.25	25.5	0.308	0.357	7.85	0.0491
0.24	27.6	0.273	0.329	7.54	0.0452
0.23	30.1	0.240	0.302	7.23	0.0415
0.22	32.9	0.210	0.277	6.91	0.0380
0.21	36.1	0.183	0.252	6.60	0.0346
0.20	39.8	0.158	0.229	6.28	0.0314
0.19	44.1	0.135	0.206	5.97	0.0284
0.18	49.1	0.115	0.185	5.65	0.0254
0.17	55.1	0.0970	0.165	5.34	0.0227
0.16	62.2	0.0809	0.146	5.03	0.0201
0.15	70.7	0.0666	0.129	4.71	0.0177
0.14	81.2	0.0542	0.112	4.40	0.0154
0.13	94.2	0.0434	0.0966	4.08	0.0133

* $\text{cm}^2/\Omega = I^2 \times C_t / \rho$ (I = Current, C_t = temperature factor, ρ = surface load W/cm²)

ALKROTHAL™

RIBBON DIMENSIONS AND PROPERTIES

Resistivity 1.25 Ω mm²/m (744 Ω /cmf). Density 7.28 g/cm³ (0.263 lb/in³).

To obtain resistance at working temperature, multiply by the factor C_t in the following table.

°C	20	100	200	300	400	500	600	700	800	900	1000	1100
C_t	1.00	1.00	1.02	1.03	1.04	1.05	1.08	1.09	1.10	1.11	1.11	1.12

WIDTH MM	THICKNESS MM	RESISTANCE AT 20°C Ω /M	SURFACE AREA PER Ω CM ² / Ω *	WEIGHT G/M	SURFACE AREA CM ² /M	CROSS SECTIONAL AREA MM ²
4	0.50	0.679	132	13.4	90.0	1.84
	0.40	0.849	103.6	10.7	88.0	1.47
	0.30	1.13	76.0	8.04	86.0	1.10
	0.20	1.70	49.5	5.36	84.0	0.736
	0.15	2.26	36.7	4.02	83.0	0.552
	0.10	3.40	24.1	2.67	82.0	0.368
3	1.0	0.453	177	20.1	80.0	2.76
	0.90	0.503	155	18.1	78.0	2.48
	0.80	0.566	134	16.1	76.0	2.21
	0.70	0.647	114	14.1	74.0	1.93
	0.60	0.755	95.4	12.1	72.0	1.66
	0.50	0.906	77.3	10.0	70.0	1.38
	0.40	1.13	60.1	8.0	68.0	1.10
	0.30	1.51	43.7	6.0	66.0	0.828
	0.20	2.26	28.3	4.0	64.0	0.552
	0.15	3.02	20.9	3.0	63.0	0.414
2.5	1.0	0.543	129	16.7	70.0	2.30
	0.90	0.604	113	15.1	68.0	2.07
	0.80	0.679	97.2	13.4	66.0	1.84
	0.70	0.776	82.4	11.7	64.0	1.61
	0.60	0.906	68.4	10.0	62.0	1.38
	0.50	1.09	55.2	8.37	60.0	1.15
	0.40	1.36	42.7	6.70	58.0	0.920
	0.30	1.81	30.9	5.02	56.0	0.690
	0.20	2.72	19.9	3.35	54.0	0.460
	0.15	3.62	14.6	2.51	53.0	0.345
2.25	1.0	0.604	107.6	15.1	65.0	2.07
	0.90	0.671	93.9	13.6	63.0	1.86
	0.80	0.755	80.8	12.1	61.0	1.66
	0.70	0.863	68.4	10.5	59.0	1.45
	0.60	1.006	56.6	9.0	57.0	1.24
	0.50	1.208	45.5	7.5	55.0	1.04

* $\text{cm}^2/\Omega = I^2 \times C_t / p$ (I = Current, C_t = temperature factor, p = surface load W/cm²)

[cont.]

[cont.]

WIDTH MM	THICKNESS MM	RESISTANCE AT 20°C Ω/M	SURFACE AREA PER Ω CM ² /Ω*	WEIGHT G/M	SURFACE AREA CM ² /M	CROSS SECTIONAL AREA MM ²
2.25	0.40	1.510	35.1	6.0	53.0	0.828
	0.30	2.013	25.3	4.5	51.0	0.621
	0.20	3.019	16.2	3.0	49.0	0.414
	0.15	4.026	11.9	2.3	48.0	0.311
	0.10	6.52	7.21	1.5	47.0	0.207
2.0	0.80	0.849	65.9	10.7	56.0	1.47
	0.70	0.970	55.6	9.4	54.0	1.29
	0.60	1.13	45.9	8.04	52.0	1.10
	0.50	1.36	36.8	6.70	50.0	0.920
	0.40	1.70	28.3	5.36	48.0	0.736
	0.30	2.26	20.3	4.02	46.0	0.552
	0.20	3.40	13.0	2.68	44.0	0.368
	0.15	4.53	9.5	2.01	43.0	0.276
	0.10	7.34	5.72	1.34	42.0	0.184
1.75	1.0	0.776	70.8	11.7	55.0	1.61
	0.90	0.863	61.4	10.5	53.0	1.45
	0.80	0.970	52.6	9.4	51.0	1.29
	0.70	1.11	44.2	8.20	49.0	1.13
	0.60	1.29	36.3	7.03	47.0	0.966
	0.50	1.55	29.0	5.86	45.0	0.805
	0.40	1.94	22.2	4.69	43.0	0.644
	0.30	2.59	15.8	3.52	41.0	0.483
	0.20	3.88	10.0	2.34	39.0	0.322
	0.15	5.18	7.34	1.76	38.0	0.242
	0.10	8.39	4.41	1.17	37.0	0.161
1.5	0.70	1.29	34.0	7.04	44.0	0.966
	0.60	1.51	27.8	6.03	42.0	0.828
	0.50	1.81	22.1	5.03	40.0	0.690
	0.40	2.26	16.8	4.02	38.0	0.552
	0.30	3.02	11.9	3.02	36.0	0.414
	0.20	4.53	7.51	2.01	34.0	0.276
	0.15	6.04	5.46	1.51	33.0	0.207
	0.10	9.06	3.53	1.01	32.0	0.138
	0.090	10.1	3.16	0.905	31.8	0.124

* $\text{cm}^2/\Omega = I^2 \times C_t / p$ (I = Current, C_t = temperature factor, p = surface load W/cm²)

[cont.]

ALKROTHAL™ RIBBON DIMENSIONS AND PROPERTIES

(cont.)

WIDTH MM	THICKNESS MM	RESISTANCE AT 20°C Ω/M	SURFACE AREA PER Ω CM ² /Ω*	WEIGHT G/M	SURFACE AREA CM ² /M	CROSS SECTIONAL AREA MM ²
1.5	0.080	11.3	2.79	0.805	31.6	0.110
1.25	0.60	1.81	20.4	5.02	37.0	0.690
	0.50	2.17	16.1	4.19	35.0	0.575
	0.40	2.72	12.1	3.35	33.0	0.460
	0.30	3.62	8.56	2.51	31.0	0.345
	0.20	5.43	5.34	1.67	29.0	0.230
	0.15	7.25	3.86	1.26	28.0	0.173
	0.10	10.9	2.48	0.837	27.0	0.115
	0.090	12.1	2.22	0.753	26.8	0.104
	0.080	13.6	1.96	0.670	26.6	0.0920
	0.070	15.5	1.70	0.586	26.4	0.0805
1.0	0.60	2.26	14.1	4.02	32.0	0.552
	0.50	2.72	11.0	3.35	30.0	0.460
	0.40	3.40	8.24	2.68	28.0	0.368
	0.30	4.53	5.74	2.01	26.0	0.276
	0.20	6.79	3.53	1.34	24.0	0.184
	0.15	9.06	2.54	1.00	23.0	0.138
	0.10	13.6	1.62	0.670	22.0	0.0920
	0.090	15.1	1.44	0.603	21.8	0.0828
	0.080	17.0	1.27	0.536	21.6	0.0736
0.9	0.50	3.02	9.27	3.01	28.0	0.414
	0.40	3.77	6.89	2.41	26.0	0.331
	0.30	5.03	4.77	1.81	24.0	0.248
	0.20	7.55	2.91	1.21	22.0	0.166
	0.15	10.1	2.09	0.904	21.0	0.124
	0.10	15.1	1.32	0.603	20.0	0.0828
	0.090	16.8	1.18	0.543	19.8	0.0745
	0.080	18.9	1.039	0.482	19.6	0.0662
	0.070	21.6	0.900	0.422	19.4	0.0580
0.8	0.40	4.25	5.65	2.14	24.0	0.294
	0.30	5.66	3.89	1.61	22.0	0.221
	0.20	8.49	2.36	1.07	20.0	0.147
	0.15	11.3	1.68	0.804	19.0	0.110
	0.10	17.0	1.060	0.536	18.0	0.0736
	0.090	18.9	0.943	0.482	17.8	0.0662
	0.080	21.2	0.829	0.429	17.6	0.0589
	0.070	24.3	0.717	0.375	17.4	0.0515
0.7	0.30	6.47	3.09	1.41	20.0	0.193
	0.20	9.7	1.85	0.938	18.0	0.129
	0.15	12.9	1.31	0.703	17.0	0.097

* $\text{cm}^2/\Omega = I^2 \times C_t / \rho$ (I = Current, C_t = temperature factor, ρ = surface load W/cm²)

(cont.)

(cont.)

WIDTH MM	THICKNESS MM	RESISTANCE AT 20°C Ω/M	SURFACE AREA PER Ω CM ² /Ω*	WEIGHT G/M	SURFACE AREA CM ² /M	CROSS SECTIONAL AREA MM ²
0.7	0.10	19.4	0.824	0.469	16.0	0.0644
	0.090	21.6	0.733	0.422	15.8	0.0580
	0.080	24.3	0.643	0.375	15.6	0.0515
	0.070	27.7	0.555	0.328	15.4	0.0451
	0.060	32.3	0.470	0.281	15.2	0.0386
0.6	0.30	7.55	2.38	1.21	18.0	0.166
	0.30	7.55	2.38	1.21	18.0	0.166
	0.20	11.3	1.41	0.804	16.0	0.110
	0.15	15.1	0.994	0.603	15.0	0.0828
	0.10	22.6	0.618	0.402	14.0	0.0552
	0.090	25.2	0.548	0.362	13.8	0.0497
	0.080	28.3	0.480	0.321	13.6	0.0442
	0.070	32.3	0.414	0.281	13.4	0.0386
	0.060	37.7	0.350	0.241	13.2	0.0331
0.5	0.050	45.3	0.287	0.201	13.0	0.0276
	0.30	9.06	1.77	1.00	16.0	0.138
	0.20	13.6	1.030	0.670	14.0	0.0920
	0.15	18.1	0.718	0.502	13.0	0.0690
	0.10	27.2	0.442	0.335	12.0	0.0460
	0.090	30.2	0.391	0.301	11.8	0.0414
	0.080	34.0	0.342	0.268	11.6	0.0368
	0.070	38.8	0.294	0.234	11.4	0.0322
	0.060	45.3	0.247	0.201	11.2	0.0276
0.4	0.050	54.3	0.202	0.167	11.0	0.0230
	0.20	17.0	0.707	0.536	12.0	0.0736
	0.15	22.6	0.486	0.402	11.0	0.0552
	0.10	34.0	0.294	0.268	10.0	0.0368
	0.090	37.7	0.260	0.241	9.80	0.0331
	0.080	42.5	0.226	0.214	9.60	0.0294
	0.070	48.5	0.194	0.188	9.40	0.0258
	0.060	56.6	0.163	0.161	9.20	0.0221
	0.050	73.4	0.123	0.134	9.00	0.0184
0.3	0.15	30.2	0.298	0.301	9.00	0.0414
	0.10	45.3	0.177	0.201	8.00	0.0276
	0.090	50.3	0.155	0.181	7.80	0.0248
	0.080	56.6	0.134	0.161	7.60	0.0221
	0.070	64.7	0.114	0.141	7.40	0.0193
	0.060	75.5	0.0954	0.121	7.20	0.0166

* $\text{cm}^2/\Omega = I^2 \times C_t / \rho$ (I = Current, C_t = temperature factor, ρ = surface load W/cm²)

NIKROTHAL® 80, NIKROTHAL TE AND NIKROTHAL 70

WIRE DIMENSIONS AND PROPERTIES

Nikrothal 80: Resistivity 1.09 Ω mm²/m (655 Ω /cmf). Density 8.30 g/cm³ (0.300 lb/in³).

Nikrothal TE: Resistivity 1.19 Ω mm²/m (716 Ω /cmf). Density 8.10 g/cm³ (0.293 lb/in³).

Nikrothal 70: Resistivity 1.18 Ω mm²/m (709 Ω /cmf). Density 8.10 g/cm³ (0.293 lb/in³).

To obtain resistance at working temperature, multiply by the factor C_t in the following table.

°C	20	100	200	300	400	500	600	700	800	900	1000	1100	1200
NIKROTHAL® 80 C_t	1.00	1.01	1.02	1.03	1.04	1.05	1.04	1.04	1.04	1.04	1.05	1.06	1.07
NIKROTHAL TE C_t	1.00	1.02	1.03	1.04	1.05	1.06	1.06	1.06	1.06	1.06	1.07	1.07	1.08
NIKROTHAL 70 C_t	1.00	1.01	1.02	1.03	1.04	1.05	1.05	1.04	1.04	1.04	1.05	1.06	1.06

DIAMETER	RESISTANCE AT 20°C	RESISTIVITY AT 20°C	WEIGHT	SURFACE AREA	CROSS SECTIONAL AREA
MM	Ω /M	CM ² / Ω *	G/M	CM ² /M	MM ²
10	0.0139	22637	652	314	78.5
9.5	0.0154	19408	588	298	70.9
9.0	0.0171	16502	528	283	63.6
8.25	0.0204	12711	444	259	53.5
8.0	0.0217	11590	417	251	50.3
7.5	0.0247	9550	367	236	44.2
7.0	0.0283	7764	319	220	38.5
6.5	0.0328	6217	275	204	33.2
6.0	0.0386	4890	235	188	28.3
5.83	0.0408	4486	222	183	26.7
5.5	0.0459	3766	197	173	23.8
5.0	0.0555	2830	163	157	19.6
4.75	0.0615	2426	147	149	17.7
4.5	0.0685	2063	132	141	15.9
4.25	0.0768	1738	118	134	14.2
4.0	0.0867	1449	104	126	12.6
3.75	0.0987	1194	91.7	118	11.0
3.65	0.104	1101	86.8	115	10.5
3.5	0.113	971	79.9	110	9.62
3.25	0.131	777	68.9	102	8.30
3.0	0.154	611	58.7	94.2	7.07
2.8	0.177	497	51.1	88.0	6.16
2.6	0.205	398	44.1	81.7	5.31
2.5	0.222	354	40.7	78.5	4.91
2.3	0.262	275	34.5	72.3	4.15
2.0	0.347	181	26.1	62.8	3.14
1.8	0.428	132	21.1	56.5	2.54
1.6	0.542	92.7	16.7	50.3	2.01
1.5	0.617	76.4	14.7	47.1	1.77
1.4	0.708	62.1	12.8	44.0	1.54

* $\text{cm}^2/\Omega = I^2 \times C_t / p$ (I = Current, C_t = temperature factor, p = surface load W/cm²)

(cont.)

For different alloys, multiply the figures in the table with:

ALLOY	RESISTANCE AT 20°C, Ω/M	SURFACE AREA PER Ω, CM ² /Ω	WEIGHT, G/M
Nikrothal® TE	1.092	0.916	0.976
Nikrothal 70	1.083	0.924	0.976

(cont.)

DIAMETER MM	RESISTANCE AT 20°C Ω/M	RESISTIVITY AT 20°C CM ² /Ω*	WEIGHT G/M	SURFACE AREA CM ² /M	CROSS SECTIONAL AREA MM ²
1.3	0.821	49.7	11.0	40.8	1.33
1.2	0.964	39.1	9.39	37.7	1.13
1.0	1.39	22.6	6.52	31.4	0.785
0.95	1.54	19.4	5.88	29.8	0.709
0.90	1.71	16.5	5.28	28.3	0.636
0.85	1.92	13.9	4.71	26.7	0.567
0.80	2.17	11.6	4.17	25.1	0.503
0.75	2.47	9.55	3.67	23.6	0.442
0.70	2.83	7.76	3.19	22.0	0.385
0.65	3.28	6.22	2.75	20.4	0.332
0.60	3.86	4.89	2.35	18.8	0.283
0.55	4.59	3.77	1.97	17.3	0.238
0.50	5.55	2.83	1.63	15.7	0.196
0.45	6.85	2.06	1.32	14.1	0.159
0.40	8.67	1.45	1.04	12.6	0.126
0.35	11.3	0.971	0.799	11.0	0.0962
0.32	13.6	0.742	0.668	10.1	0.0804
0.30	15.4	0.611	0.587	9.42	0.0707
0.28	17.7	0.497	0.511	8.80	0.0616
0.25	22.2	0.354	0.407	7.85	0.0491
0.22	28.7	0.241	0.316	6.91	0.0380
0.20	34.7	0.181	0.261	6.28	0.0314
0.19	38.4	0.155	0.235	5.97	0.0284
0.18	42.8	0.132	0.211	5.65	0.0254
0.17	48.0	0.111	0.188	5.34	0.0227
0.16	54.2	0.0927	0.167	5.03	0.0201
0.15	61.7	0.0764	0.147	4.71	0.0177
0.14	70.8	0.0621	0.128	4.40	0.0154
0.13	82.1	0.0497	0.110	4.08	0.0133

* $\text{cm}^2/\Omega = I^2 \times C_t / p$ (I = Current, C_t = temperature factor, p = surface load W/cm²)

NIKROTHAL[®] 60

WIRE DIMENSIONS AND PROPERTIES

Resistivity 1.11 Ω mm²/m (668 Ω /cmf). Density 8.20 g/cm³ (0.296 lb/in³).

To obtain resistivity at working temperature, multiply by factor C_t in following table.

°C	20	100	200	300	400	500	600	700	800	900	1000	1100	1200
C_t	1.00	1.02	1.04	1.05	1.06	1.08	1.09	1.09	1.10	1.10	1.11	1.12	1.13

DIAMETER MM	RESISTANCE AT 20°C Ω /M	RESISTIVITY AT 20°C CM^2/Ω^*	WEIGHT G/M	SURFACE AREA CM^2/M	CROSS SECTIONAL AREA MM ²
6.0	0.0393	4801	232	188	28.3
5.5	0.0467	3698	195	173	23.8
5.0	0.0565	2779	161	157	19.6
4.75	0.0626	2382	145	149	17.7
4.5	0.0698	2026	130	141	15.9
4.25	0.0782	1706	116	134	14.2
4.0	0.0883	1423	103	126	12.6
3.75	0.101	1172	90.6	118	11.0
3.5	0.115	953	78.9	110	9.62
3.25	0.134	763	68.0	102	8.30
3.0	0.157	600	58.0	94.2	7.07
2.8	0.180	488	50.5	88.0	6.16
2.6	0.209	391	43.5	81.7	5.31
2.5	0.226	347	40.3	78.5	4.91
2.2	0.292	237	31.2	69.1	3.80
2.0	0.353	178	25.8	62.8	3.14
1.9	0.391	152	23.2	59.7	2.84
1.8	0.436	130	20.9	56.5	2.54
1.7	0.489	109	18.6	53.4	2.27
1.6	0.552	91.0	16.5	50.3	2.01
1.5	0.628	75.0	14.5	47.1	1.77
1.4	0.721	61.0	12.6	44.0	1.54
1.3	0.836	48.8	10.9	40.8	1.33
1.2	0.981	38.4	9.27	37.7	1.13
1.1	1.17	29.6	7.79	34.6	0.950
1.0	1.41	22.2	6.44	31.4	0.785
0.95	1.57	19.1	5.81	29.8	0.709
0.90	1.74	16.2	5.22	28.3	0.636
0.85	1.96	13.7	4.65	26.7	0.567
0.80	2.21	11.4	4.12	25.1	0.503

* $cm^2/\Omega = I^2 \times C_t / \rho$ (I = Current, C_t = temperature factor, ρ = surface load W/cm²)

(cont.)

[cont.]

DIAMETER MM	RESISTANCE AT 20°C Ω/M	RESISTIVITY AT 20°C CM ² /Ω*	WEIGHT G/M	SURFACE AREA CM ² /M	CROSS SECTIONAL AREA MM ²
0.75	2.51	9.38	3.62	23.6	0.442
0.70	2.88	7.62	3.16	22.0	0.385
0.65	3.35	6.10	2.72	20.4	0.332
0.60	3.93	4.80	2.32	18.8	0.283
0.55	4.67	3.70	1.95	17.3	0.238
0.50	5.65	2.78	1.61	15.7	0.196
0.475	6.26	2.38	1.45	14.9	0.177
0.45	6.98	2.03	1.30	14.1	0.159
0.425	7.82	1.71	1.16	13.4	0.142
0.40	8.83	1.42	1.03	12.6	0.126
0.375	10.1	1.17	0.906	11.8	
0.35	11.5	0.953	0.789	11.0	
0.32	13.8	0.728	0.659	10.1	
0.30	15.7	0.600	0.580	9.42	
0.28	18.0	0.488	0.505	8.80	
0.26	20.9	0.391	0.435	8.17	
0.25	22.6	0.347	0.403	7.85	
0.24	24.5	0.307	0.371	7.54	
0.23	26.7	0.270	0.341	7.23	
0.22	29.2	0.237	0.312	6.91	
0.21	32.0	0.206	0.284	6.60	
0.20	35.3	0.178	0.258	6.28	
0.19	39.1	0.152	0.232	5.97	
0.18	43.6	0.130	0.209	5.65	
0.17	48.9	0.109	0.186	5.34	
0.16	55.2	0.0910	0.165	5.03	
0.15	62.8	0.0750	0.145	4.71	
0.14	72.1	0.0610	0.126	4.40	
0.13	83.6	0.0488	0.109	4.08	

* $\text{cm}^2/\Omega = I^2 \times C_t / p$ (I = Current, C_t = temperature factor, p = surface load W/cm²)

NIKROTHAL® 40, NIKROTHAL 20

WIRE DIMENSIONS AND PROPERTIES

Nikrothal 40: Resistivity 1.04 Ω mm²/m (626 Ω/cm²). Density 7.90 g/cm³ (0.285 lb/in³).

Nikrothal 20: Resistivity 0.95 Ω mm²/m (572 Ω/cm²). Density 7.80 g/cm³ (0.281 lb/in³).

To obtain resistance at working temperature, multiply by the factor C_t in the following table.

°C	20	100	200	300	400	500	600	700	800	900	1000	1100
NIKROTHAL® 40 C _t	1.00	1.03	1.06	1.10	1.12	1.15	1.17	1.19	1.21	1.22	1.23	1.24
NIKROTHAL 20 C _t	1.00	1.04	1.10	1.14	1.17	1.21	1.12	1.16	1.28	1.30	1.32	1.34

DIAMETER MM	RESISTANCE AT 20°C Ω/M	RESISTIVITY AT 20°C CM ² /Ω*	WEIGHT G/M	SURFACE AREA CM ² /M	CROSS SECTIONAL AREA MM ²
10	0.0139	22637	652	314	78.5
9.5	0.0154	19408	588	298	70.9
9.0	0.0171	16502	528	283	63.6
8.25	0.0204	12711	444	259	53.5
8.0	0.0217	11590	417	251	50.3
7.5	0.0247	9550	367	236	44.2
7.0	0.0283	7764	319	220	38.5
6.5	0.0328	6217	275	204	33.2
6.0	0.0386	4890	235	188	28.3
5.83	0.0408	4486	222	183	26.7
5.5	0.0459	3766	197	173	23.8
5.0	0.0555	2830	163	157	19.6
4.75	0.0615	2426	147	149	17.7
4.5	0.0685	2063	132	141	15.9
4.25	0.0768	1738	118	134	14.2
4.0	0.0867	1449	104	126	12.6
3.75	0.0987	1194	91.7	118	11.0
3.65	0.104	1101	86.8	115	10.5
3.5	0.113	971	79.9	110	9.62
3.25	0.131	777	68.9	102	8.30
3.0	0.154	611	58.7	94.2	7.07
2.8	0.177	497	51.1	88.0	6.16
2.6	0.205	398	44.1	81.7	5.31
2.5	0.222	354	40.7	78.5	4.91
2.3	0.262	275	34.5	72.3	4.15
2.0	0.347	181	26.1	62.8	3.14
1.8	0.428	132	21.1	56.5	2.54
1.6	0.542	92.7	16.7	50.3	2.01
1.5	0.617	76.4	14.7	47.1	1.77
1.4	0.708	62.1	12.8	44.0	1.54

* cm²/Ω = I² × C_t / p (I = Current, C_t = temperature factor, p = surface load W/cm²)

(cont.)

For different alloys, multiply the figures in the table with:

ALLOY	RESISTANCE AT 20°C, Ω/M	SURFACE AREA PER Ω, CM ² /Ω	WEIGHT, G/M
NIKROTHAL® 20	0.913	1.095	0.987

(cont.)

DIAMETER MM	RESISTANCE AT 20°C Ω/M	RESISTIVITY AT 20°C CM ² /Ω*	WEIGHT G/M	SURFACE AREA CM ² /M	CROSS SECTIONAL AREA MM ²
1.3	0.821	49.7	11.0	40.8	1.33
1.2	0.964	39.1	9.39	37.7	1.13
1.0	1.39	22.6	6.52	31.4	0.785
0.95	1.54	19.4	5.88	29.8	0.709
0.90	1.71	16.5	5.28	28.3	0.636
0.85	1.92	13.9	4.71	26.7	0.567
0.80	2.17	11.6	4.17	25.1	0.503
0.75	2.47	9.55	3.67	23.6	0.442
0.70	2.83	7.76	3.19	22.0	0.385
0.65	3.28	6.22	2.75	20.4	0.332
0.60	3.86	4.89	2.35	18.8	0.283
0.55	4.59	3.77	1.97	17.3	0.238
0.50	5.55	2.83	1.63	15.7	0.196
0.45	6.85	2.06	1.32	14.1	0.159
0.40	8.67	1.45	1.04	12.6	0.126
0.35	11.3	0.971	0.799	11.0	0.0962
0.32	13.6	0.742	0.668	10.1	0.0804
0.30	15.4	0.611	0.587	9.42	0.0707
0.28	17.7	0.497	0.511	8.80	0.0616
0.25	22.2	0.354	0.407	7.85	0.0491
0.22	28.7	0.241	0.316	6.91	0.0380
0.20	34.7	0.181	0.261	6.28	0.0314
0.19	38.4	0.155	0.235	5.97	0.0284
0.18	42.8	0.132	0.211	5.65	0.0254
0.17	48.0	0.111	0.188	5.34	0.0227
0.16	54.2	0.0927	0.167	5.03	0.0201
0.15	61.7	0.0764	0.147	4.71	0.0177
0.14	70.8	0.0621	0.128	4.40	0.0154
0.13	82.1	0.0497	0.110	4.08	0.0133

* $\text{cm}^2/\Omega = I^2 \times C_t / p$ (I = Current, C_t = temperature factor, p = surface load W/cm²)

NIKROTHAL[®] 80, NIKROTHAL 60 AND NIKROTHAL 40

RIBBON DIMENSIONS AND PROPERTIES

Nikrothal 80: Resistivity 1.09 Ω mm²/m (655 Ω /cmf). Density 8.30 g/cm³ (0.300 lb/in³).

Nikrothal 60: Resistivity 1.11 Ω mm²/m (668 Ω /cmf). Density 8.20 g/cm³ (0.296 lb/in³).

Nikrothal 40: Resistivity 1.04 Ω mm²/m (626 Ω /cmf). Density 7.90 g/cm³ (0.285 lb/in³).

To obtain resistance at working temperature, multiply by the factor C_t in the following table.

°C	20	100	200	300	400	500	600	700	800	900	1000	1100	1200
NIKROTHAL[®] 80 C_t	1.00	1.01	1.02	1.03	1.04	1.05	1.04	1.04	1.04	1.04	1.05	1.06	1.07
NIKROTHAL 60 C_t	1.00	1.02	1.04	1.05	1.06	1.08	1.09	1.09	1.10	1.10	1.11	1.12	1.13
NIKROTHAL 40 C_t	1.00	1.03	1.06	1.10	1.12	1.15	1.17	1.19	1.21	1.22	1.23	1.24	

WIDTH MM	THICKNESS MM	RESISTANCE AT 20°C Ω /M	SURFACE AREA PER Ω CM ² / Ω *	WEIGHT G/M	SURFACE AREA CM ² /M	CROSS SECTIONAL AREA MM ²
4	0.50	0.592	152	15.3	90.0	1.84
	0.40	0.740	119	12.2	88.0	1.47
	0.30	0.987	87.1	9.16	86.0	1.10
	0.20	1.48	56.7	6.11	84.0	0.736
	0.15	1.97	42.0	4.58	83.0	0.552
	0.10	2.96	27.7	3.05	82.0	0.368
3	1.0	0.395	203	22.9	80.0	2.76
	0.90	0.439	178	20.6	78.0	2.48
	0.80	0.494	154	18.3	76.0	2.21
	0.70	0.564	131	16.0	74.0	1.93
	0.60	0.658	109	13.7	72.0	1.66
	0.50	0.790	88.6	11.5	70.0	1.38
	0.40	0.987	68.9	9.16	68.0	1.10
	0.30	1.32	50.1	6.87	66.0	0.828
	0.20	1.97	32.4	4.58	64.0	0.552
	0.15	2.63	23.9	3.44	63.0	0.414
2.5	1.0	0.474	148	19.1	70.0	2.30
	0.90	0.527	129	17.2	68.0	2.07
	0.80	0.592	111	15.3	66.0	1.84
	0.70	0.677	94.5	13.4	64.0	1.61
	0.60	0.790	78.5	11.5	62.0	1.38
	0.50	0.948	63.3	9.55	60.0	1.15
	0.40	1.18	49.0	7.64	58.0	0.920
	0.30	1.58	35.4	5.73	56.0	0.690
	0.20	2.37	22.8	3.82	54.0	0.460
	0.15	3.16	16.8	2.86	53.0	0.345
2.0	1.0	4.74	11.0	1.91	52.0	0.230
	0.80	0.740	75.6	12.2	56.0	1.47
	0.70	0.846	63.8	10.7	54.0	1.29

* $\text{cm}^2/\Omega = I^2 \times C_t / \rho$ (I = Current, C_t = temperature factor, ρ = surface load W/cm²)

[cont.]

For different alloys, multiply the figures in the table with:

ALLOY	RESISTANCE AT 20°C, Ω/M	SURFACE AREA PER Ω, CM ² /Ω	WEIGHT, G/M
NIKROTHAL® 60	1.018	0.984	0.988
NIKROTHAL 40	0.954	1.048	0.952

(cont.)

WIDTH MM	THICKNESS MM	RESISTANCE AT 20°C Ω/M	SURFACE AREA PER Ω CM ² /Ω*	WEIGHT G/M	SURFACE AREA CM ² /M	CROSS SECTIONAL AREA MM ²
2.0	0.60	0.987	52.7	9.16	52.0	1.10
	0.50	1.18	42.2	7.64	50.0	0.920
	0.40	1.48	32.4	6.11	48.0	0.736
	0.30	1.97	23.3	4.58	46.0	0.552
	0.20	2.96	14.9	3.05	44.0	0.368
	0.15	3.95	10.9	2.29	43.0	0.276
1.8	0.10	5.92	7.09	1.53	42.0	0.184
	0.80	0.823	63.2	11.0	52.0	1.32
	0.70	0.940	53.2	9.62	50.0	1.16
	0.60	1.10	43.8	8.25	48.0	0.994
	0.50	1.32	34.9	6.87	46.0	0.828
	0.40	1.65	26.7	5.50	44.0	0.662
	0.30	2.19	19.1	4.12	42.0	0.497
	0.20	3.29	12.2	2.75	40.0	0.331
1.5	0.15	4.39	8.89	2.06	39.0	0.248
	0.10	6.58	5.77	1.37	38.0	0.166
	0.80	0.987	46.6	9.16	46.0	1.10
	0.70	1.13	39.0	8.02	44.0	0.966
	0.60	1.32	31.9	6.87	42.0	0.828
	0.50	1.58	25.3	5.73	40.0	0.690
	0.40	1.97	19.2	4.58	38.0	0.552
	0.30	2.63	13.7	3.44	36.0	0.414
1.2	0.20	3.95	8.61	2.29	34.0	0.276
	0.15	5.27	6.27	1.72	33.0	0.207
	0.10	7.90	4.05	1.15	32.0	0.138
	0.090	8.78	3.62	1.03	31.8	0.124
	0.080	9.87	3.20	0.916	31.6	0.110
	0.80	1.23	32.4	7.33	40.0	0.883
	0.70	1.41	26.9	6.41	38.0	0.773
	0.60	1.65	21.9	5.50	36.0	0.662

* $\text{cm}^2/\Omega = I^2 \times C_t / p$ (I = Current, C_t = temperature factor, p = surface load W/cm²)

(cont.)

NIKROTHAL® 80, NIKROTHAL 60 AND NIKROTHAL 40 RIBBON DIMENSIONS AND PROPERTIES

(cont.)

WIDTH MM	THICKNESS MM	RESISTANCE AT 20°C Ω/M	SURFACE AREA PER Ω CM ² /Ω*	WEIGHT G/M	SURFACE AREA CM ² /M	CROSS SECTIONAL AREA MM ²
1.2	0.50	1.97	17.2	4.58	34.0	0.552
	0.40	2.47	13.0	3.67	32.0	0.442
	0.30	3.29	9.12	2.75	30.0	0.331
	0.20	4.94	5.67	1.83	28.0	0.221
	0.15	6.58	4.10	1.37	27.0	0.166
	0.10	9.87	2.63	0.916	26.0	0.110
	0.090	11.0	2.35	0.825	25.8	0.099
	0.080	12.3	2.07	0.733	25.6	0.088
1.0	0.60	1.97	16.2	4.58	32.0	0.552
	0.50	2.37	12.7	3.82	30.0	0.460
	0.40	2.96	9.45	3.05	28.0	0.368
	0.30	3.95	6.58	2.29	26.0	0.276
	0.20	5.92	4.05	1.53	24.0	0.184
	0.15	7.90	2.91	1.15	23.0	0.138
	0.10	11.8	1.86	0.764	22.0	0.0920
	0.090	13.2	1.66	0.687	21.8	0.0828
0.9	0.080	14.8	1.46	0.611	21.6	0.0736
	0.50	2.63	10.6	3.44	28.0	0.414
	0.40	3.29	7.90	2.75	26.0	0.331
	0.30	4.39	5.47	2.06	24.0	0.248
	0.20	6.58	3.34	1.37	22.0	0.166
	0.15	8.78	2.39	1.03	21.0	0.124
	0.10	13.2	1.52	0.687	20.0	0.0828
	0.090	14.6	1.35	0.619	19.8	0.0745
0.8	0.080	16.5	1.19	0.550	19.6	0.0662
	0.070	18.8	1.03	0.481	19.4	0.0580
	0.40	3.70	6.48	2.44	24.0	0.294
	0.30	4.94	4.46	1.83	22.0	0.221
	0.20	7.40	2.70	1.22	20.0	0.147
	0.15	9.87	1.92	0.916	19.0	0.110
	0.10	14.8	1.22	0.611	18.0	0.0736
	0.090	16.5	1.08	0.550	17.8	0.0662
0.7	0.080	18.5	0.951	0.489	17.6	0.0589
	0.070	21.2	0.822	0.428	17.4	0.0515
	0.10	14.8	1.22	0.611	18.0	0.0736
	0.090	16.5	1.08	0.550	17.8	0.0662
	0.30	5.64	3.54	1.60	20.0	0.193
	0.20	8.46	2.13	1.07	18.0	0.129

* $cm^2/\Omega = I^2 \times C_t / \rho$ (I = Current, C_t = temperature factor, ρ = surface load W/cm²)

(cont.)

(cont.)

WIDTH MM	THICKNESS MM	RESISTANCE AT 20°C Ω/M	SURFACE AREA PER Ω CM ² /Ω*	WEIGHT G/M	SURFACE AREA CM ² /M	CROSS SECTIONAL AREA MM ²
0.7	0.15	11.3	1.51	0.802	17.0	0.097
	0.10	16.9	0.945	0.535	16.0	0.0644
	0.090	18.8	0.840	0.481	15.8	0.0580
	0.080	21.2	0.737	0.428	15.6	0.0515
	0.070	24.2	0.637	0.374	15.4	0.0451
	0.060	28.2	0.539	0.321	15.2	0.0386
0.6	0.30	6.58	2.73	1.37	18.0	0.166
	0.20	9.87	1.62	0.916	16.0	0.110
	0.15	13.2	1.14	0.687	15.0	0.0828
	0.10	19.7	0.709	0.458	14.0	0.0552
	0.090	21.9	0.629	0.412	13.8	0.0497
	0.080	24.7	0.551	0.367	13.6	0.0442
	0.070	28.2	0.475	0.321	13.4	0.0386
	0.060	32.9	0.401	0.275	13.2	0.0331
	0.050	39.5	0.329	0.229	13.0	0.0276
0.5	0.30	7.90	2.03	1.15	16.0	0.138
	0.20	11.8	1.18	0.764	14.0	0.0920
	0.15	15.8	0.823	0.573	13.0	0.0690
	0.10	23.7	0.506	0.382	12.0	0.0460
	0.090	26.3	0.448	0.344	11.8	0.0414
	0.080	29.6	0.392	0.305	11.6	0.0368
	0.070	33.9	0.337	0.267	11.4	0.0322
	0.060	39.5	0.284	0.229	11.2	0.0276
	0.050	47.4	0.232	0.191	11.0	0.0230
0.4	0.20	14.8	0.810	0.611	12.0	0.0736
	0.15	19.7	0.557	0.458	11.0	0.0552
	0.10	29.6	0.338	0.305	10.0	0.0368
	0.090	32.9	0.298	0.275	9.80	0.0331
	0.080	37.0	0.259	0.244	9.60	0.0294
	0.070	42.3	0.222	0.214	9.40	0.0258
	0.060	49.4	0.186	0.183	9.20	0.0221
	0.050	59.2	0.152	0.153	9.00	0.0184
	0.3	0.15	26.3	0.342	0.344	9.00
0.10		39.5	0.203	0.229	8.00	0.0276
0.090		43.9	0.178	0.206	7.80	0.0248
0.080		49.4	0.154	0.183	7.60	0.0221
0.070		56.4	0.131	0.160	7.40	0.0193
0.060		65.8	0.109	0.137	7.20	0.0166

* $\text{cm}^2/\Omega = I^2 \times C_t / \rho$ (I = Current, C_t = temperature factor, ρ = surface load W/cm²)

NIFETHAL® 70

WIRE DIMENSIONS AND PROPERTIES

Resistivity 0.20 Ω mm²/m (120 Ω /cmf). Density 8.45 g/cm³ (0.305 lb/in³).

To obtain resistivity at working temperature, multiply by factor C_t in following table.

°C	20	100	150	200	250	300	350	400	450	500
C_t	1.00	1.42	1.68	1.91	2.19	2.47	2.75	3.03	3.34	3.66

DIAMETER MM	RESISTANCE AT 20°C Ω /M	SURFACE AREA PER Ω CM ² / Ω *	WEIGHT G/M	SURFACE AREA CM ² /M	CROSS SECTIONAL AREA MM ²
1.8	0.0786	719	21.5	56.5	2.54
1.7	0.0881	606	19.2	53.4	2.27
1.6	0.0995	505	17.0	50.3	2.01
1.5	0.113	416	14.9	47.1	1.77
1.4	0.130	339	13.0	44.0	1.54
1.3	0.151	271	11.2	40.8	1.33
1.2	0.177	213	9.56	37.7	1.13
1.1	0.210	164	8.03	34.6	0.950
1.0	0.255	123	6.64	31.4	0.785
0.95	0.282	106	5.99	29.8	0.709
0.90	0.314	89.9	5.38	28.3	0.636
0.85	0.352	75.8	4.79	26.7	0.567
0.80	0.398	63.2	4.25	25.1	0.503
0.75	0.453	52.0	3.73	23.6	0.442
0.70	0.520	42.3	3.25	22.0	0.385
0.65	0.603	33.9	2.80	20.4	0.332
0.60	0.707	26.6	2.39	18.8	0.283
0.55	0.842	20.5	2.01	17.3	0.238
0.50	1.02	15.4	1.66	15.7	0.196
0.475	1.13	13.2	1.50	14.9	0.177
0.45	1.26	11.2	1.34	14.1	0.159
0.425	1.41	9.47	1.20	13.4	0.142
0.40	1.59	7.90	1.06	12.6	0.126
0.375	1.81	6.51	0.933	11.8	0.110

* $\text{cm}^2/\Omega = I^2 \times C_t / p$ (I = Current, C_t = temperature factor, p = surface load W/cm²)

[cont.]

[cont.]

DIAMETER MM	RESISTANCE AT 20°C Ω/M	SURFACE AREA PER Ω CM ² /Ω*	WEIGHT G/M	SURFACE AREA CM ² /M	CROSS SECTIONAL AREA MM ²
0.35	2.08	5.29	0.813	11.0	0.0962
0.32	2.49	4.04	0.680	10.1	0.0804
0.30	2.83	3.33	0.597	9.42	0.0707
0.28	3.25	2.71	0.520	8.80	0.0616
0.26	3.77	2.17	0.449	8.17	0.0531
0.25	4.07	1.93	0.415	7.85	0.0491
0.24	4.42	1.71	0.382	7.54	0.0452
0.23	4.81	1.50	0.351	7.23	0.0415
0.22	5.26	1.31	0.321	6.91	0.0380
0.21	5.77	1.14	0.293	6.60	0.0346
0.20	6.37	0.987	0.265	6.28	0.0314
0.19	7.05	0.846	0.240	5.97	0.0284
0.18	7.86	0.719	0.215	5.65	0.0254
0.17	8.81	0.606	0.192	5.34	0.0227
0.16	9.95	0.505	0.170	5.03	0.0201
0.15	11.3	0.416	0.149	4.71	0.0177
0.14	13.0	0.339	0.130	4.40	0.0154
0.13	15.1	0.271	0.112	4.08	0.0133
0.12	17.7	0.213	0.0956	3.77	0.0113
0.11	21.0	0.164	0.0803	3.46	0.00950
0.10	25.5	0.123	0.0664	3.14	0.00785

* $\text{cm}^2/\Omega = I^2 \times C_t / p$ (I = Current, C_t = temperature factor, p = surface load W/cm²)

NIFETHAL® 52

WIRE DIMENSIONS AND PROPERTIES

Resistivity 0.43 Ω mm²/m (220 Ω /cmf). Density 8.20 g/cm³ (0.296 lb/in³).

To obtain resistivity at working temperature, multiply by factor C_t in following table.

°C	20	100	150	200	250	300	350	400	450	500
C_t	1.00	1.33	1.53	1.73	1.93	2.13	2.32	2.49	2.64	2.77

DIAMETER MM	RESISTANCE AT 20°C Ω /M	SURFACE AREA PER Ω CM ² / Ω *	WEIGHT G/M	SURFACE AREA CM ² /M	CROSS SECTIONAL AREA MM ²
1.8	0.169	335	20.9	56.5	2.54
1.7	0.189	282	18.6	53.4	2.27
1.6	0.214	235	16.5	50.3	2.01
1.5	0.243	194	14.5	47.1	1.77
1.4	0.279	157	12.6	44.0	1.54
1.3	0.324	126	10.9	40.8	1.33
1.2	0.380	99.2	9.27	37.7	1.13
1.1	0.452	76.4	7.79	34.6	0.950
1.0	0.547	57.4	6.44	31.4	0.785
0.95	0.607	49.2	5.81	29.8	0.709
0.90	0.676	41.8	5.22	28.3	0.636
0.85	0.758	35.2	4.65	26.7	0.567
0.80	0.855	29.4	4.12	25.1	0.503
0.75	0.973	24.2	3.62	23.6	0.442
0.70	1.12	19.7	3.16	22.0	0.385
0.65	1.30	15.8	2.72	20.4	0.332
0.60	1.52	12.4	2.32	18.8	0.283
0.55	1.81	9.55	1.95	17.3	0.238
0.50	2.19	7.17	1.61	15.7	0.196
0.475	2.43	6.15	1.45	14.9	0.177
0.45	2.70	5.23	1.30	14.1	0.159
0.425	3.03	4.40	1.16	13.4	0.142
0.40	3.42	3.67	1.030	12.6	0.126
0.375	3.89	3.03	0.906	11.8	0.110

* $\text{cm}^2/\Omega = I^2 \times C_t / p$ (I = Current, C_t = temperature factor, p = surface load W/cm²)

[cont.]

[cont.]

DIAMETER MM	RESISTANCE AT 20°C Ω/M	SURFACE AREA PER Ω CM ² /Ω*	WEIGHT G/M	SURFACE AREA CM ² /M	CROSS SECTIONAL AREA MM ²
0.35	4.47	2.46	0.789	11.0	0.0962
0.32	5.35	1.88	0.659	10.1	0.0804
0.30	6.08	1.55	0.580	9.42	0.0707
0.28	6.98	1.26	0.505	8.80	0.0616
0.26	8.10	1.01	0.435	8.17	0.0531
0.25	8.76	0.897	0.403	7.85	0.0491
0.24	9.51	0.793	0.371	7.54	0.0452
0.23	10.3	0.698	0.341	7.23	0.0415
0.22	11.3	0.611	0.312	6.91	0.0380
0.21	12.4	0.531	0.284	6.60	0.0346
0.20	13.7	0.459	0.258	6.28	0.0314
0.19	15.2	0.394	0.232	5.97	0.0284
0.18	16.9	0.335	0.209	5.65	0.0254
0.17	18.9	0.282	0.186	5.34	0.0227
0.16	21.4	0.235	0.165	5.03	0.0201
0.15	24.3	0.194	0.145	4.71	0.0177
0.14	27.9	0.157	0.126	4.40	0.0154
0.13	32.4	0.126	0.1088	4.08	0.0133
0.12	38.0	0.0992	0.0927	3.77	0.0113
0.11	45.2	0.0764	0.0779	3.46	0.00950
0.10	54.7	0.0574	0.0644	3.14	0.00785

* $\text{cm}^2/\Omega = I^2 \times C_t / p$ (I = Current, C_t = temperature factor, p = surface load W/cm²)

CUPROTHAL®

WIRE DIMENSIONS AND PROPERTIES

Cuprothal 49:	Resistivity 0.49 Ω mm ² /m (295 Ω/cm ²).	Density 8.90 g/cm ³ (0.321 lb/in ³).
Cuprothal 30:	Resistivity 0.30 Ω mm ² /m (180 Ω/cm ²).	Density 8.90 g/cm ³ (0.321 lb/in ³).
Cuprothal 15:	Resistivity 0.15 Ω mm ² /m (90 Ω/cm ²).	Density 8.90 g/cm ³ (0.321 lb/in ³).
Cuprothal 10:	Resistivity 0.10 Ω mm ² /m (60 Ω/cm ²).	Density 8.90 g/cm ³ (0.321 lb/in ³).
Cuprothal 05:	Resistivity 0.05 Ω mm ² /m (30 Ω/cm ²).	Density 8.90 g/cm ³ (0.321 lb/in ³).

To obtain resistance at working temperature, multiply by the factor C_t in the following table.

°C	20	100	200	300	400	500	600
CUPROTHAL® 49 C_T	1.000	1.002	1.002	1.001	1.005	1.017	1.037
CUPROTHAL 30 C_T	1.000	1.020	1.030	1.040	1.060	–	–
CUPROTHAL 15 C_T	1.000	1.035	1.070	1.110	1.150	–	–
CUPROTHAL 10 C_T	1.000	1.060	1.110	1.190	–	–	–
CUPROTHAL 05 C_T	1.000	1.110	1.250	1.400	–	–	–

DIAMETER	RESISTANCE AT 20°C	SURFACE AREA PER Ω	WEIGHT	SURFACE AREA	CROSS SECTIONAL AREA
MM	Ω/M	CM ² /Ω*	G/M	CM ² /M	MM ²
10	0.0062	50355	699	314	78.5
9.5	0.0069	43173	631	298	70.9
9.0	0.0077	36709	566	283	63.6
8.25	0.0092	28275	476	259	53.5
8.0	0.0097	25782	447	251	50.3
7.5	0.0111	21244	393	236	44.2
7.35	0.0115	19994	378	231	42.4
7.0	0.0127	17272	343	220	38.5
6.5	0.0148	13829	295	204	33.2
6.0	0.0173	10877	252	188	28.3
5.5	0.0206	8378	211	173	23.8
5.0	0.0250	6294	175	157	19.6
4.75	0.0277	5397	158	149	17.7
4.5	0.0308	4589	142	141	15.9
4.25	0.0345	3866	126	134	14.2
4.0	0.0390	3223	112	126	12.6
3.75	0.0444	2655	98.3	118	11.0
3.5	0.0509	2159	85.6	110	9.62
3.25	0.0591	1729	73.8	102	8.30
3.0	0.0693	1360	62.9	94.2	7.07
2.8	0.0796	1105	54.8	88.0	6.16
2.6	0.0923	885	47.3	81.7	5.31
2.5	0.100	787	43.7	78.5	4.91
2.2	0.129	536	33.8	69.1	3.80
2.0	0.156	403	28.0	62.8	3.14
1.9	0.173	345	25.2	59.7	2.84
1.8	0.193	294	22.6	56.5	2.54
1.7	0.216	247	20.2	53.4	2.27
1.6	0.244	206	17.9	50.3	2.01
1.5	0.277	170	15.7	47.1	1.77

* cm²/Ω = I² × C_t / p (I = Current, C_t = temperature factor, p = surface load W/cm²)

[cont.]

For different alloys, multiply the figures in the table with:

ALLOY	RESISTANCE AT 20°C, Ω/M	SURFACE AREA PER Ω, CM ² /Ω	WEIGHT, G/M
CUPROTHAL® 49	1.0	1.0	1.0
CUPROTHAL 30	0.612	1.63	1.0
CUPROTHAL 15	0.306	3.29	1.0
CUPROTHAL 10	0.204	4.93	1.0
CUPROTHAL 05	0.102	9.86	1.0

(cont.)

DIAMETER MM	RESISTANCE AT 20°C Ω/M	SURFACE AREA PER Ω CM ² /Ω*	WEIGHT G/M	SURFACE AREA CM ² /M	CROSS SECTIONAL AREA MM ²
1.4	0.318	138	13.7	44.0	1.54
1.3	0.369	111	11.8	40.8	1.33
1.2	0.433	87.0	10.1	37.7	1.13
1.1	0.516	67.0	8.46	34.6	0.950
1.0	0.624	50.4	6.99	31.4	0.785
0.95	0.691	43.2	6.31	29.8	0.709
0.90	0.770	36.7	5.66	28.3	0.636
0.85	0.864	30.9	5.05	26.7	0.567
0.80	0.975	25.8	4.47	25.1	0.503
0.75	1.11	21.2	3.93	23.6	0.442
0.70	1.27	17.3	3.43	22.0	0.385
0.65	1.48	13.8	2.95	20.4	0.332
0.60	1.73	10.9	2.52	18.8	0.283
0.55	2.06	8.38	2.11	17.3	0.238
0.50	2.50	6.29	1.75	15.7	0.196
0.475	2.77	5.40	1.58	14.9	0.177
0.45	3.08	4.59	1.42	14.1	0.159
0.425	3.45	3.87	1.26	13.4	0.142
0.40	3.90	3.22	1.12	12.6	0.126
0.375	4.44	2.66	0.983	11.8	
0.35	5.09	2.16	0.856	11.0	
0.32	6.09	1.65	0.716	10.1	
0.30	6.93	1.36	0.629	9.42	
0.28	7.96	1.11	0.548	8.80	
0.26	9.23	0.885	0.473	8.17	
0.25	10.0	0.787	0.437	7.85	
0.24	10.8	0.696	0.403	7.54	
0.23	11.8	0.613	0.370	7.23	
0.22	12.9	0.536	0.338	6.91	
0.21	14.1	0.466	0.308	6.60	
0.20	15.6	0.403	0.280	6.28	
0.19	17.3	0.345	0.252	5.97	
0.18	19.3	0.294	0.226	5.65	
0.17	21.6	0.247	0.202	5.34	
0.16	24.4	0.2063	0.179	5.03	
0.15	27.7	0.1699	0.157	4.71	
0.14	31.8	0.1382	0.137	4.40	
0.13	36.9	0.1106	0.118	4.08	

* $\text{cm}^2/\Omega = I^2 \times C_t / p$ (I = Current, C_t = temperature factor, p = surface load W/cm²)

CUPROTHAL® 49

RIBBON DIMENSIONS AND PROPERTIES

Resistivity 0.49 Ω mm²/m (295 Ω /cmf). Density 8.90 g/cm³ (0.321 lb/in³).

To obtain resistance at working temperature, multiply by the factor C_t in the following table.

°C	20	100	200	300	400	500	600
C_t	1.000	1.002	1.002	1.001	1.005	1.017	1.037

WIDTH MM	THICKNESS MM	RESISTANCE AT 20°C Ω /M	SURFACE AREA PER Ω CM ² / Ω *	WEIGHT G/M	SURFACE AREA CM ² /M	CROSS SECTIONAL AREA MM ²
4	0.50	0.266	338	16.4	90.0	1.84
	0.40	0.333	264	13.1	88.0	1.47
	0.30	0.444	193.8	9.83	86.0	1.10
	0.20	0.666	126.2	6.55	84.0	0.736
	0.15	0.888	93.5	4.91	83.0	0.552
	0.10	1.33	61.6	3.28	82.0	0.368
3	1.0	0.178	451	24.6	80.0	2.76
	0.90	0.197	395	22.1	78.0	2.48
	0.80	0.222	342	19.7	76.0	2.21
	0.70	0.254	292	17.2	74.0	1.93
	0.60	0.296	243	14.7	72.0	1.66
	0.50	0.355	197	12.3	70.0	1.38
	0.40	0.444	153	9.83	68.0	1.10
	0.30	0.592	112	7.37	66.0	0.828
	0.20	0.888	72.1	4.91	64.0	0.552
	0.15	1.18	53.2	3.68	63.0	0.414
2.5	1.0	0.213	329	20.5	70.0	2.30
	0.90	0.237	287	18.4	68.0	2.07
	0.80	0.266	248	16.4	66.0	1.84
	0.70	0.304	210	14.3	64.0	1.61
	0.60	0.355	175	12.3	62.0	1.38
	0.50	0.426	141	10.2	60.0	1.15
	0.40	0.533	109	8.19	58.0	0.920
	0.30	0.710	78.9	6.14	56.0	0.690
	0.20	1.07	50.7	4.09	54.0	0.460
	0.15	1.42	37.3	3.07	53.0	0.345
	0.10	2.13	24.4	2.05	52.0	0.230
	2.0	0.80	0.333	168	13.1	56.0
0.70		0.380	142	11.5	54.0	1.29
0.60		0.444	117	9.83	52.0	1.10
0.50		0.533	93.9	8.19	50.0	0.920

* $\text{cm}^2/\Omega = I^2 \times C_t / p$ (I = Current, C_t = temperature factor, p = surface load W/cm²)

(cont.)

[cont.]

WIDTH MM	THICKNESS MM	RESISTANCE AT 20°C Ω/M	SURFACE AREA PER Ω CM ² /Ω*	WEIGHT G/M	SURFACE AREA CM ² /M	CROSS SECTIONAL AREA MM ²
2.0	0.40	0.666	72.1	6.55	48.0	0.736
	0.30	0.888	51.8	4.91	46.0	0.552
	0.20	1.33	33.0	3.28	44.0	0.368
	0.15	1.78	24.2	2.46	43.0	0.276
	0.10	2.66	15.77	1.64	42.0	0.184
1.8	0.80	0.370	141	11.8	52.0	1.32
	0.70	0.423	118	10.3	50.0	1.16
	0.60	0.493	97.3	8.84	48.0	0.994
	0.50	0.592	77.7	7.37	46.0	0.828
	0.40	0.740	59.5	5.90	44.0	0.662
	0.30	0.986	42.6	4.42	42.0	0.497
	0.20	1.48	27.0	2.95	40.0	0.331
	0.15	1.97	19.77	2.21	39.0	0.248
1.5	0.10	2.96	12.84	1.47	38.0	0.166
	0.80	0.444	104	9.83	46.0	1.10
	0.70	0.507	86.7	8.60	44.0	0.966
	0.60	0.592	71.0	7.37	42.0	0.828
	0.50	0.710	56.3	6.14	40.0	0.690
	0.40	0.888	42.8	4.91	38.0	0.552
	0.30	1.18	30.4	3.68	36.0	0.414
	0.20	1.78	19.2	2.46	34.0	0.276
	0.15	2.37	13.9	1.84	33.0	0.207
	0.10	3.55	9.01	1.23	32.0	0.138
1.2	0.090	3.95	8.06	1.11	31.8	0.124
	0.080	4.44	7.12	0.983	31.6	0.110
	0.80	0.555	72.1	7.86	40.0	0.883
	0.70	0.634	59.9	6.88	38.0	0.773
	0.60	0.740	48.7	5.90	36.0	0.662
	0.50	0.888	38.3	4.91	34.0	0.552
	0.40	1.11	28.8	3.93	32.0	0.442
	0.30	1.48	20.3	2.95	30.0	0.331
0.20	2.22	12.6	1.97	28.0	0.221	

* $\text{cm}^2/\Omega = I^2 \times C_t / p$ (I = Current, C_t = temperature factor, p = surface load W/cm²)

[cont.]

CUPROTHAL® 49 RIBBON DIMENSIONS AND PROPERTIES

[cont.]

WIDTH MM	THICKNESS MM	RESISTANCE AT 20°C Ω/M	SURFACE AREA PER Ω CM ² /Ω*	WEIGHT G/M	SURFACE AREA CM ² /M	CROSS SECTIONAL AREA MM ²
1.2	0.15	2.96	9.12	1.47	27.0	0.166
	0.10	4.44	5.86	0.983	26.0	0.110
	0.090	4.93	5.23	0.884	25.8	0.099
	0.080	5.55	4.61	0.786	25.6	0.088
1.0	0.60	0.89	36.0	4.91	32.0	0.552
	0.50	1.1	28.2	4.09	30.0	0.460
	0.40	1.3	21.0	3.28	28.0	0.368
	0.30	1.8	14.6	2.46	26.0	0.276
	0.20	2.7	9.01	1.64	24.0	0.184
	0.15	3.6	6.48	1.23	23.0	0.138
	0.10	5.3	4.13	0.819	22.0	0.0920
	0.090	5.9	3.68	0.737	21.8	0.0828
	0.080	6.7	3.24	0.655	21.6	0.0736
	0.9	0.50	1.2	23.7	3.68	28.0
0.40		1.5	17.6	2.95	26.0	0.331
0.30		2.0	12.2	2.21	24.0	0.248
0.20		3.0	7.44	1.47	22.0	0.166
0.15		3.9	5.32	1.11	21.0	0.124
0.10		5.9	3.38	0.737	20.0	0.0828
0.090		6.6	3.01	0.663	19.8	0.0745
0.080		7.4	2.65	0.590	19.6	0.0662
0.070		8.5	2.29	0.516	19.4	0.0580
0.8		0.40	1.66	14.42	2.62	24.0
	0.30	2.22	9.91	1.97	22.0	0.221
	0.20	3.33	6.01	1.31	20.0	0.147
	0.15	4.44	4.28	0.983	19.0	0.110
	0.10	6.66	2.70	0.655	18.0	0.0736
	0.090	7.40	2.41	0.590	17.8	0.0662
	0.080	8.32	2.11	0.524	17.6	0.0589
	0.070	9.51	1.83	0.459	17.4	0.0515
0.7	0.30	2.54	7.89	1.72	20.0	0.193
	0.20	3.80	4.73	1.15	18.0	0.129
	0.15	5.07	3.35	0.860	17.0	0.0966
	0.10	7.61	2.10	0.573	16.0	0.0644
	0.090	8.45	1.87	0.516	15.8	0.0580
	0.080	9.51	1.64	0.459	15.6	0.0515

* $\text{cm}^2/\Omega = I^2 \times C_t / \rho$ (I = Current, C_t = temperature factor, ρ = surface load W/cm²)

[cont.]

(cont.)

WIDTH MM	THICKNESS MM	RESISTANCE AT 20°C Ω/M	SURFACE AREA PER Ω CM ² /Ω*	WEIGHT G/M	SURFACE AREA CM ² /M	CROSS SECTIONAL AREA MM ²
0.7	0.070	10.9	1.42	0.401	15.4	0.0451
	0.060	12.7	1.20	0.344	15.2	0.0386
0.6	0.30	2.96	6.08	1.47	18.0	0.166
	0.20	4.44	3.60	0.983	16.0	0.110
	0.15	5.92	2.53	0.737	15.0	0.0828
	0.10	8.88	1.58	0.491	14.0	0.0552
	0.090	9.86	1.40	0.442	13.8	0.0497
	0.080	11.1	1.23	0.393	13.6	0.0442
	0.070	12.7	1.06	0.344	13.4	0.0386
	0.060	14.8	0.892	0.295	13.2	0.0331
0.5	0.050	17.8	0.732	0.246	13.0	0.0276
	0.30	3.55	4.51	1.23	16.0	0.138
	0.20	5.33	2.63	0.819	14.0	0.0920
	0.15	7.10	1.83	0.614	13.0	0.0690
	0.10	10.7	1.13	0.409	12.0	0.0460
	0.090	11.8	0.997	0.368	11.8	0.0414
	0.080	13.3	0.871	0.328	11.6	0.0368
	0.070	15.2	0.749	0.287	11.4	0.0322
0.4	0.060	17.8	0.631	0.246	11.2	0.0276
	0.050	21.3	0.516	0.205	11.0	0.0230
	0.20	6.66	1.80	0.655	12.0	0.0736
	0.15	8.88	1.24	0.491	11.0	0.0552
	0.10	13.3	0.751	0.328	10.0	0.0368
	0.090	14.8	0.662	0.295	9.80	0.0331
	0.080	16.6	0.577	0.262	9.60	0.0294
	0.070	19.0	0.494	0.229	9.40	0.0258
0.3	0.060	22.2	0.415	0.197	9.20	0.0221
	0.050	26.6	0.338	0.164	9.00	0.0184
	0.15	11.8	0.760	0.368	9.00	0.0414
	0.10	17.8	0.451	0.246	8.00	0.0276
	0.090	19.7	0.395	0.221	7.80	0.0248
	0.080	22.2	0.342	0.197	7.60	0.0221
	0.070	25.4	0.292	0.172	7.40	0.0193
	0.060	29.6	0.243	0.147	7.20	0.0166

* $\text{cm}^2/\Omega = I^2 \times C_1 / \rho$ (I = Current, C_1 = temperature factor, ρ = surface load W/cm²)

APPENDIX

LIST OF SYMBOLS

The symbols used comply with internationally approved standards.

The following symbols are used:

SYMBOL	MEANING	UNIT FOR CALCULATION	
		METRIC	IMPERIAL
A_c	Surface area of heating conductor	cm ²	in ²
b	Width (ribbon or strip)	mm	in
C_t	Temperature factor (ratio of resistivity at operating temperature to resistivity at room temperature)		
d	Wire diameter	mm	in
D	Outer coil diameter	mm	in
I	Current	A	A
L	Length of heating conductor	m	ft
L_e	Coil length	mm	in
n	Number of turns		
p	Surface load of heating element	W/cm ²	W/in ²
P	Power	W	W
q	Cross-sectional area of heating conductor	mm ²	in ²
r	Relative pitch		
R_T	Resistance at working temperature	Ω	Ω
R_{20}	Resistance at room temperature (20°C, 68°F)	Ω	Ω
s	Pitch	mm	in
t	Thickness (ribbon or strip)	mm	in
T	Temperature	K, °C	K, °F
U	Voltage	V	V
α	Temperature coefficient of resistivity	K ⁻¹	°F ⁻¹
γ	Density (old marking)	g/cm ³	lb/in ³
ρ	Resistivity	Ω mm ² /m	Ω/smf Ω/cm ² *
10	Balancing factor used in the formulas makes possible that the values can be used with units of section 1: e.g. wire diameter, d , in millimeter (mm) or inch (in) is different from length of heating conductor, l , in meter (m) or foot (ft)		

FORMULAS AND DEFINITIONS

The following formulas and definitions are applied to all applications.

DEFINITION: Resistivity, ρ $\Omega\text{mm}^2/\text{m}$ (Ω/cmf)

The resistance of a conductor, R_{20} , is directly proportional to its length, L and inversely proportional to its cross-sectional area, q :

$$R_{20} = \rho \frac{L}{q} \quad \Omega \quad [1]$$

The proportional constant, ρ is defined as the resistivity of the material and is temperature dependent. The unit of ρ is $\Omega\text{mm}^2/\text{m}$ (Ω/cmf).

DEFINITION: Temperature factor, C_t

Resistivity or change in resistance with temperature, is non-linear for most resistance heating alloys. Hence, the temperature factor, C_t , is often used instead of temperature coefficient. C_t is defined as the ratio between the resistivity or resistance at some selected temperature T °C and the resistivity or resistance at 20°C (68°F).

$$R_T = C_t \cdot R_{20} \quad \Omega \quad [2]$$

$$C_t = \frac{R_T}{R_{20}} \quad [3]$$

$$C_t = 1 + (T - 20)\alpha \quad (\text{where } T \text{ is in } ^\circ\text{C}) \quad [4]$$

DEFINITION: Surface load, p W/cm^2 (W/in^2)

The surface load of a heating conductor, p , is its power, P , divided by its surface area, A_c .

$$p = \frac{P}{A_c} \quad \text{W}/\text{cm}^2 \quad (\text{W}/\text{in}^2) \quad [5]$$

Wire

$$A_c = \pi \cdot d \cdot L \cdot 10 \quad (\text{metric}) \quad [6]$$

$$A_c = \pi \cdot d \cdot L \cdot 12 \quad (\text{imperial}) \quad [6]$$

Strip/ribbon

$$A_c = 2 \cdot (b + t) \cdot L \cdot 10 \quad (\text{metric}) \quad [7]$$

$$A_c = 2 \cdot (b + t) \cdot L \cdot 12 \quad (\text{imperial}) \quad [7]$$

General formulas

$$U = R_T \cdot I \quad \text{V} \quad [8]$$

$$P = U \cdot I \quad \text{W} \quad [9]$$

Combining equations [8] and [9] gives:

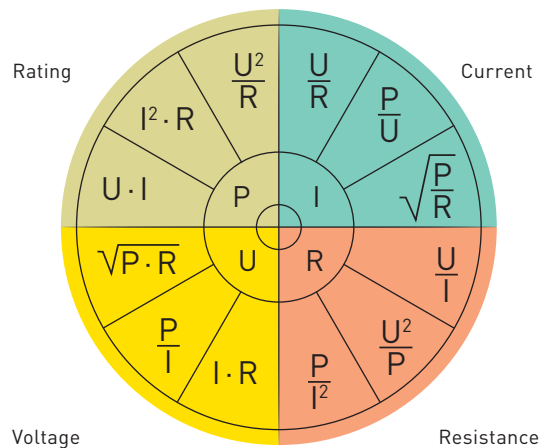

Combining equations [2], [5], [8] and [9] gives:

$$\frac{A_c}{R_{20}} = \frac{I^2 \cdot C_t}{p} \quad \text{cm}^2/\Omega \quad (\text{in}^2/\Omega) \quad [10]$$

The ratio $\frac{A_c}{R_{20}}$, used for determining wire, strip or ribbon size, is tabulated for all alloys in the handbook for 'Resistance heating alloys and systems for industrial furnaces'.

DEFINITION: Cross sectional area, q mm² (in²)

Round wire

$$q = \frac{\pi}{4} \cdot d^2 \quad \text{mm}^2 \text{ (in}^2\text{)} \quad [11]$$

Combining equations [1], [5], [6] and [11] gives the wire diameter, d :

$$d = 3 \sqrt{\frac{4}{\pi^2} \cdot \frac{\rho \cdot P}{p \cdot R_{20}}} \quad \text{mm (in)} \quad [12]$$

$$d = 3 \sqrt{\frac{4}{\pi^2} \cdot \frac{\rho \cdot P}{p \cdot R_{20}} \cdot \frac{1}{10}} \quad \text{(metric)} \quad [12]$$

$$d = 3 \sqrt{\frac{4}{\pi^2} \cdot \frac{\rho \cdot P}{p \cdot R_{20}} \cdot \frac{1}{15.28 \cdot 10^6}} \quad \text{(imp.)} \quad [12]$$

Example:

- $\rho = 1.35 \Omega \text{ mm}^2/\text{m}$ (812 Ω/cmf) for Kanthal D (according to section 2)
- $P = 1000 \text{ W}$
- $p = 8 \text{ W/cm}^2$ (51.6 W/in^2)
- $R = 40 \Omega$

According to equation [12]:

$$d = 3 \sqrt{\frac{4}{\pi^2} \cdot \frac{1.35 \cdot 1000}{8 \cdot 40} \cdot \frac{1}{10}} = 0.55 \text{ mm}$$

$$d = 3 \sqrt{\frac{4}{\pi^2} \cdot \frac{812 \cdot 1000}{51.6 \cdot 40} \cdot \frac{1}{15.28 \cdot 10^6}} = 0.022 \text{ in}$$

Strip

$$q = b \cdot t \quad \text{mm}^2 \text{ (in}^2\text{)} \quad [13]$$

Ribbon

Since ribbons are made by flattening round wires, the cross-sectional area is somewhat smaller depending on size, than equation [13] indicates. As a rule of thumb, a factor 0.92 is used.

$$q = 0.92 \cdot b \cdot t \quad \text{mm}^2 \text{ (in}^2\text{)} \quad [14]$$

Lately, investigations have shown that a more correct way of expressing the cross-sectional area of ribbon is:

$$q = 0.985 \cdot \frac{t}{2 \cdot b} \cdot b \cdot t \quad [14']$$

(Equation [14] is, however, used throughout this handbook).

DEFINITION: Number of turns, n

$$n = \frac{L_e}{s} \quad [15]$$

DEFINITION: Coil pitch, s mm (in)

A round wire is often wound as a coil. For calculating coil pitch, s , the equation [16] applies:

$$\frac{\pi \cdot (D-d)}{s} + 1 = \frac{L}{L_e} \rightarrow s = \frac{\pi \cdot (D-d)}{\sqrt{\left(\frac{L}{L_e}\right)^2 - 1}} \quad \text{mm} \quad [16]$$

$$s = \frac{\pi \cdot (D-d)}{\sqrt{\left(\frac{L \cdot 1000}{L_e}\right)^2 - 1}} \quad \text{(metric)} \quad [16']$$

$$s = \frac{\pi \cdot (D-d)}{\sqrt{\left(\frac{L \cdot 12}{L_e}\right)^2 - 1}} \quad \text{(imperial)} \quad [16']$$

When the pitch, s , is small relatively to coil diameter, D , and wire diameter, d .

Then $\frac{s}{\pi(D-d)} \ll 1$, so that equation [16] can be simplified to:

$$s = \frac{\pi \cdot (D-d)}{L} \cdot L_e \quad \text{mm (in)} \quad [17]$$

DEFINITION: Relative pitch, r

The ratio s/d is often used. It is called the relative pitch or the stretch factor, and may affect the heat dissipation from the coil.

$$r = \frac{s}{d} \quad [18]$$

The ratio D/d is essential for the coiling operation, as well as the mechanical stability of the coil in a hot state.

FORMULAS FOR VALUES IN TABLES

In chapter Tables values for surface area, weight and resistance of each material and dimension are calculated per meter. Furthermore the cross sectional area and area/Ω are presented.

The formulas below include the unit correction.

Metric units

Resistance per meter, $R_{20/m}$ Ω/m

Based on equation [1]

Wire

$$R_{20/m} = \frac{\rho \cdot 4}{\pi \cdot d^2} \quad [1']$$

Strip

$$R_{20/m} = \frac{\rho}{b \cdot t} \quad [1']$$

Ribbon

$$R_{20/m} = \frac{\rho}{0.92 \cdot b \cdot t} \quad [1']$$

Weight per meter, m_m g/m

$m = \text{volume} \cdot \gamma = q \cdot l \cdot \gamma \rightarrow m_m = q \cdot \gamma$

Wire

$$m_m = \frac{\pi \cdot d^2 \cdot \gamma}{4} \quad [19]$$

Strip

$$m_m = b \cdot t \cdot \gamma \quad [19]$$

Ribbon

$$m_m = 0.92 \cdot b \cdot t \cdot \gamma \quad [19]$$

Surface area per meter, $A_{C/m}$ cm²/m

Based on equation [6] respectively [7]

Wire

$$A_{C/m} = \pi \cdot d \cdot 10 \quad [6']$$

Strip/ribbon

$$A_{C/m} = 2 \cdot (b + t) \cdot 10 \quad [7']$$

Cross sectional area, q mm²

Based on equation [11] [13] respectively [14]

Wire

$$q = \frac{\pi}{4} \cdot d^2 \quad [11']$$

Strip

$$q = b \cdot t \quad [13']$$

Ribbon

$$q = 0.92 \cdot b \cdot t \quad [14']$$

Surface area per Ω cm²/Ω

Combining [1'] and [6'] respectively [1'] and [7']

Wire

$$\frac{A_{C/m}}{R_{20/m}} = \frac{\pi \cdot d \cdot q \cdot 10}{\rho} = \frac{\pi^2 \cdot d^3 \cdot 10}{\rho \cdot 4}$$

Strip

$$\begin{aligned} \frac{A_{C/m}}{R_{20/m}} &= \frac{2 \cdot (b + t) \cdot b \cdot t \cdot 10}{\rho} = \\ &= \frac{20 \cdot (b + t) \cdot b \cdot t}{\rho} \end{aligned}$$

Ribbon

$$\frac{A_{c/m}}{R_{20/m}} = \frac{2 \cdot (b+t) \cdot 0.92 \cdot b \cdot t \cdot 10}{\rho} =$$

$$= \frac{18.4 \cdot (b+t) \cdot b \cdot t}{\rho}$$

Other equations which could be helpful

Length per kilo, L_{kg} m/kg

Based on equation [19] $\rightarrow L_{kg} = \frac{1000}{m_m}$

Wire

$$L_{kg} = \frac{1000 \cdot 4}{\pi \cdot d^2 \cdot \gamma} = \frac{4000}{\pi \cdot d^2 \cdot \gamma} \quad [19']$$

Strip

$$L_{kg} = \frac{1000}{b \cdot t \cdot \gamma} \quad [19']$$

Ribbon

$$L_{kg} = \frac{1000}{0.92 \cdot b \cdot t \cdot \gamma} = \frac{1087}{b \cdot t \cdot \gamma} \quad [19']$$

Resistance per kilo, R_{kg} Ω /kg

Combining [1'] and [19'] \rightarrow

$$R_{kg} = \frac{R_{20/m} \cdot 1000}{m_m} = \frac{R \cdot 1000}{q \cdot q \cdot \gamma} = \frac{R \cdot 1000}{q^2 \cdot \gamma}$$

Wire

$$R_{kg} = \frac{\rho \cdot 1000}{\frac{\pi \cdot d^2}{4} \cdot \gamma} = \frac{\rho \cdot 1000}{\frac{\pi^2 \cdot d^4}{16} \cdot \gamma}$$

Strip

$$R_{kg} = \frac{\rho \cdot 1000}{b^2 \cdot t^2 \cdot \gamma}$$

Ribbon

$$R_{kg} = \frac{\rho \cdot 1000}{b^2 \cdot t^2 \cdot 0.92^2 \cdot \gamma} = \frac{\rho \cdot 1181.5}{b^2 \cdot t^2 \cdot \gamma}$$

Relationship between metric and imperial units

1 Ω mm ² /m ($\mu\Omega$ m)	= 601.54 Ω /cmf
1 Ω mm ² /m ($\mu\Omega$ m)	= 472.44 Ω /smf
1 Ω /smf	= 1.2732 Ω /cmf

1 inch (in)	= 1000 mil	= 0.0254 m
1 foot (ft)	= 12 in	= 0.3048 m
1 mil	= 0.001 inch	= 0.0254 mm
1 W/cm ²		= 6.45 W/in ²
1 W/in ²		= 0.155 W/cm ²

Imperial units

$\rho'_{wire} = \Omega$ /cfm respectively

$\rho''_{strip/ribbon} = \Omega$ /smf

Resistance per foot, $R_{20/ft}$ Ω /ft

Based on equation [1]

Wire

$$R_{20/ft} = \frac{\rho'}{d^2 \cdot 10^6} \quad [1']$$

Strip

$$R_{20/ft} = \frac{\rho''}{b \cdot t \cdot 10^6} \quad [1']$$

Ribbon

$$R_{20/ft} = \frac{\rho''}{0.92 \cdot b \cdot t \cdot 10^6} \quad [1']$$

Weight per foot, m_m lb/ft

$m = \text{volume} \cdot \gamma = q \cdot l \cdot \gamma \rightarrow m_{ft} = q \cdot \gamma$

Wire

$$m_{ft} = \frac{\pi \cdot d^2 \cdot \gamma \cdot 12}{4} = \pi \cdot d^2 \cdot \gamma \cdot 3 \quad [19']$$

Strip

$$m_{ft} = b \cdot t \cdot \gamma \cdot 12 \quad [19']$$

Ribbon

$$m_{ft} = 0.92 \cdot b \cdot t \cdot \gamma \cdot 12 = 11.04 \cdot b \cdot t \cdot \gamma \quad [19']$$

Surface area per foot, $A_{C/ft}$ in²/ft

Based on equation [6] respectively [7]

Wire

$$A_{C/ft} = \pi \cdot d \cdot 12 \quad [6']$$

Strip/ribbon

$$A_{C/ft} = 2 \cdot (b + t) \cdot 12 \quad [7']$$

Cross sectional area, q in²

Based on equation [11] [13] respectively [14]

Wire

$$q = \frac{\pi}{4} \cdot d^2 \quad [11']$$

Strip

$$q = b \cdot t \quad [13']$$

Ribbon

$$q = 0.92 \cdot b \cdot t \quad [14']$$

Surface area per Ω in²/ Ω

Combining [1'] and [6'] respectively [1'] and [7']

Wire

$$\frac{A_{C/ft}}{R_{20/ft}} = \frac{\pi \cdot d \cdot q \cdot 12 \cdot 10^6}{\rho'} = \frac{\pi^2 \cdot d^3 \cdot 3 \cdot 10^6}{\rho'}$$

Strip

$$\begin{aligned} \frac{A_{C/ft}}{R_{20/ft}} &= \frac{2 \cdot (b + t) \cdot b \cdot t \cdot 12 \cdot 10^6}{\rho''} = \\ &= \frac{24 \cdot (b + t) \cdot b \cdot t \cdot 10^6}{\rho''} \end{aligned}$$

Ribbon

$$\begin{aligned} \frac{A_{C/ft}}{R_{20/ft}} &= \frac{2 \cdot (b + t) \cdot 0.92 \cdot b \cdot t \cdot 12 \cdot 10^6}{\rho''} = \\ &= \frac{22.08 \cdot (b + t) \cdot b \cdot t \cdot 10^6}{\rho''} \end{aligned}$$

Other equations which could be helpful

Length per pound, L_{lb} ft/lbBased on equation [19] $\rightarrow L_{lb} = \frac{1}{m_{ft}}$ **Wire**

$$L_{lb} = \frac{4}{\pi \cdot d^2 \cdot \gamma \cdot 12} = \frac{1}{\pi \cdot d^2 \cdot \gamma \cdot 3} \quad [19']$$

Strip

$$L_{lb} = \frac{1}{b \cdot t \cdot \gamma \cdot 12} \quad [19']$$

Ribbon

$$L_{lb} = \frac{1}{0.92 \cdot b \cdot t \cdot \gamma \cdot 12} = \frac{1}{b \cdot t \cdot \gamma \cdot 11.04} \quad [19']$$

Resistance per pound, R_{lb} Ω /lbCombining [1'] and [19'] \rightarrow

$$R_{lb} = \frac{R_{20/ft}}{m_{ft}} = \frac{\rho'}{q \cdot q \cdot \gamma} = \frac{\rho'}{q^2 \cdot \gamma}$$

Wire

$$R_{lb} = \frac{\rho'}{d^2 \cdot 10^6 \cdot \pi \cdot d^2 \cdot \gamma \cdot 3} = \frac{\rho'}{d^4 \cdot 10^6 \cdot \pi \cdot \gamma \cdot 3}$$

Strip

$$R_{lb} = \frac{\rho''}{b^2 \cdot t^2 \cdot \gamma \cdot 12 \cdot 10^6}$$

Ribbon

$$\begin{aligned} R_{lb} &= \frac{\rho''}{b^2 \cdot t^2 \cdot 0.92^2 \cdot \gamma \cdot 12 \cdot 10^6} = \\ &= \frac{\rho''}{b^2 \cdot t^2 \cdot 10.16 \cdot \gamma \cdot 10^6} \end{aligned}$$

DESIGN CALCULATIONS FOR HEATING ELEMENTS

In this section an element is defined as the combination of heating wire and any supporting and connecting materials. Electrical appliances equipped with heating elements are being used in domestic as well as industrial applications. Domestic applications are e.g. cooking, heating of fluids, drying, ironing, space heating and special purposes such as heating of beds, aquariums, saunas, soldering irons and paint strippers. Typical industrial applications are heat treatment, hardening and drying of inks, paints and lacquers. In vehicles, seats, engines and rear view mirrors are frequently electrically heated.

The appliance and the heating element must meet requirements regarding performance, cost of raw material and manufacturing, together with life and safety. The requirements may be opposed to each other. A long life and a high degree of safety means a low wire temperature, which results in a long heating up time and often also high raw material costs.

Domestic heating appliances must not cause harm to individuals or damage to property. Safety specifications for each market may influence the design of the appliance and the element and limit their temperature.

The life of a well designed element depends upon the make and the type of wire used. Our FeCrAl and NiCr(Fe) wires have excellent properties at high temperature and provide the best possible life. It should be kept in mind that the life of a wire increases with wire diameter and decreasing wire temperature.

WIRE TEMPERATURE

For embedded and supported element types the wire temperature depends upon both the wire and the element surface load. For the suspended element types the element surface load in most cases cannot be defined. In addition to the surface load, ambient temperature, heating dissipating conditions and presence and location of other elements will influence the wire temperature and therefore also the choice of wire surface load and element surface load.



Life test of element.

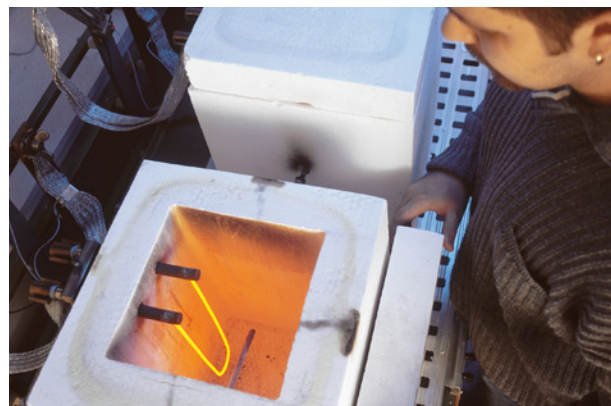

Life test of 4 mm wire.

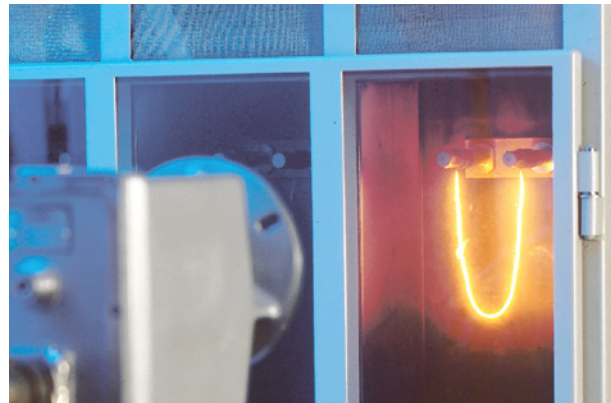

Bash test of alloys.

SURFACE LOAD

When calculating an element, voltage and rating are normally known. The surface load for the heating element means the rating divided by element surface area of the energized wire. Usually a range of surface loads and not one single figure is listed in the mentioned tables. The choice within the range depends upon the requirements for the element. It also depends upon voltage, rating and dimensions available. A high voltage and a low rating will result in a thin wire, which at the same temperature has a shorter life than a thick wire and will therefore require a low wire surface load.

The wire surface is then found as the ratio between rating and wire surface load.

SURFACE AND RESISTANCE

After having calculated the resistance in cold state, the ratio between the surface and the resistance is found. This ratio is listed for all wire types and wire dimensions in the handbook for 'Resistance heating alloys and systems for industrial furnaces', and the correct wire size can therefore easily be found from these tables.

COIL PARAMETERS

The ratio between coil and wire diameter (D/d) must be calculated in order to check that the coil can easily be manufactured. Recommended ratio (D/d) should be in the range of 5–12. In case of supported elements, this ratio must be compared with the deformation curve at page 17. When the coil length and diameter are known, the coil pitch (s) can be estimated by formula [17] in the Appendix. Coil pitch (s) is normally 2–4 times the wire diameter (d). For quartz tube heaters a smaller pitch is normally used. Preoxidized coils made from Kanthal® FeCrAl in such elements can be used tightly wound.

For a straight wire on a threaded ceramic rod and for many elements of the suspended type the wire length is fixed. The resistance per meter can then be calculated and the wire size found from the tables of the handbook for 'Resistance heating alloys and systems for industrial furnaces'. If this results in too high a surface load in case of a ribbon, a wider and thinner ribbon having the same cross-section can be chosen.

METAL SHEATHED TUBULAR ELEMENT

The calculation of a metal sheathed tubular element is more complicated since the resistance is reduced 10 to 30% as a result of the compression of the element. For such elements, the tube surface load is first determined according to the use of the element. The wire surface load is normally 2 to 4 times greater. After calculating the resistance from rating and voltage, it has to be increased 10 to 30% in order to get the resistance after coiling. The wire surface will become 2 to 7% smaller when the element has been reduced. Since the tube length is increased through compression by rolling, the tube surface often remains unaltered.



Glowing coil inside tubular heating elements.

EXAMPLES

Tubular element for a flat iron

Rating, P	1000 W
Voltage, U	220 V
Final tube diameter	8 mm (0.315 in)
Final tube length	300 mm (11.8 in)

If the terminal length inside the tube is 2×25 mm the coil length (L_e) will be
 $L_e = 300 \text{ mm} - (2 \times 25 \text{ mm}) = 250 \text{ mm}$ (9.8 in).

Hot resistance based on equation [8] and [9]

$$R = \frac{U^2}{P} = \frac{220^2}{1000} = 48.4 \Omega$$

Tube surface load based on equation [5]

$$p_{\text{tube}} = \frac{P}{A_{\text{tube}}} = \frac{P}{\pi \cdot d_{\text{tube}} \cdot L_e \cdot 0.01} =$$

$$= \frac{1000}{\pi \cdot 8 \cdot 250 \cdot 0.01} = 15.91 \frac{\text{W}}{\text{cm}^2} \quad (103 \text{ W/in}^2)$$

Wire surface load inside tube. Factor 3 is used as a rule of thumb:

$$p_{\text{wire}} = 3 \cdot p_{\text{tube}} \quad [20]$$

$$p_{\text{wire}} = 3 \cdot p_{\text{tube}} = 3 \cdot 15.91 = 47.74 \approx$$

$$\approx 48 \frac{\text{W}}{\text{cm}^2} \quad (309 \text{ W/in}^2)$$

Wire surface based on equation [5]

$$p_{\text{wire}} = \frac{P}{A_c} \rightarrow$$

$$A_c = \frac{P}{p_{\text{wire}}} = \frac{1000}{48} = 20.83 \approx 21 \text{ cm}^2 \quad (3.3 \text{ in}^2)$$

Kanthal[®] D is a sensible choice and an average wire temperature of 700°C (1290°F) likely. Due to temperature factor of resistance ($C_t = 1.05$ for Kanthal D, table on page 48).

Resistance at room temperature based on equation [2]

$$R_T = C_t \cdot R_{20} \rightarrow$$

$$R_{20} = \frac{R_T}{C_t} = \frac{48.4}{1.05} = 46.09 \approx 46.1 \Omega$$

The ratio between wire surface and resistance is:

$$\frac{A_c}{R_{20}} = \frac{21}{46.1} = 0.455 \frac{\text{cm}^2}{\Omega} \quad (0.071 \text{ in}^2/\Omega)$$

Based on the table for Kanthal D on page 48, this is corresponding to a wire size of about 0.3 mm (0.012 in).

We assume that a steel tube of initially 9.5 mm (0.37 in) diameter is being used and can then expect a resistance reduction of about 30% upon rolling.

The resistance of the coil should therefore be about 65.3Ω . The wire surface prior to compression is 7% bigger, or 22.5 cm^2 (3.49 in^2), and the ratio between wire surface and resistance $0.34 \text{ cm}^2/\Omega$ ($0.053 \text{ in}^2/\Omega$).

The corresponding wire size is 0.26 mm (0.01 in). Tests with this wire size have to be made in order to check the resistance reduction as a result of compression.

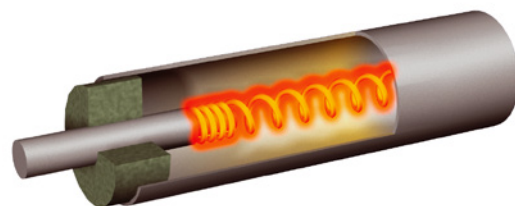

Metal sheathed tubular element.

Coil suspended on a Mica-cross, element for a hair dryer

Rating, P	350 W
Voltage, U	55 V
Length of coil, l	250 mm (9.8 in)
Coil outer diameter, D	6 mm (0.236 in)

For this application a surface load, p , of 7 W/cm^2 (45.16 W/in^2) is reasonable.

Wire surface based on equation [5]

$$p = \frac{P}{A_c} \rightarrow A_c = \frac{P}{p} = \frac{350}{7} = 50 \text{ cm}^2 (7.75 \text{ in}^2)$$

Assuming a wire temperature of 600°C (1110°F) and choosing Kanthal D with an C_t value of 1.04.

Hot- and cold resistance based on combining equations [8], [9] and [2]

$$R_T = \frac{U^2}{P} = \frac{55^2}{350} = 8.64 \Omega$$

$$R_{20} = \frac{R_T}{C_t} = 8.31 \Omega$$

By calculating the surface area to cold resistance ratio, a suitable wire dimension is found, combining [1'] and [6'], [7']

Wire

$$\frac{A_c}{R_{20}} = \frac{50 \text{ cm}^2}{8.31 \Omega} = 6.01 \frac{\text{cm}^2}{\Omega} \quad 0.93 \text{ in}^2/\Omega$$

According to table for Kanthal D $\emptyset 0.70 \text{ mm}$ (0.0276 in) has an surface area to resistance ratio of $6.27 \text{ cm}^2/\Omega$ ($0.97 \text{ in}^2/\Omega$).

D/d ratio has to be considered since too low as well as too high values will create problems in the coiling process. Verifying the geometry of the coil, suitable values for the D/d ratio should be between 6 and 12. In this case:

$$\frac{D}{d} = \frac{6 \text{ mm}}{0.7 \text{ mm}} = 8.6$$

Length of wire is calculated as the ratio between resistance needed and resistance per meter (table on page 48, Kanthal D, $d = 0.7 \text{ mm}$, $R_{20/m} = 3.51 \Omega/\text{m}$).

Wire length:

$$L = \frac{R_{20}}{R_{20/m}} = \frac{8.31 \Omega \cdot \text{m}}{3.51 \Omega} = 2.367 \text{ m}$$

Coil pitch, s , based on equation [17]

$$s = \frac{n \cdot (D - d) \cdot L_e}{L} = \frac{n \cdot (7 - 0.7) \cdot 250}{2370} = 2.09 \text{ mm}$$

Relative pitch based on equation [18]

$$r = \frac{s}{d} = \frac{2.09}{0.7} = 2.98$$

Surface load based on [5]

$$p = \frac{P}{A_{c/m} \cdot L} = \frac{350}{22 \cdot 2.37} = 6.7 \text{ W/cm}^2$$

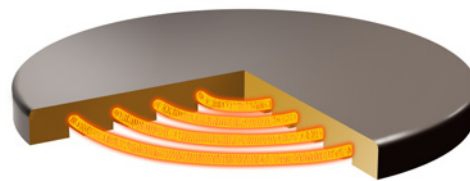

Coils in grooved metal plates.

CONVERSION TABLES

WIRE GAUGE CONVERSION TABLE

GAUGE NO.	AWG OR B&S		SWG	
	MM	IN	MM	IN
4-0	11.684	0.4600	10.1600	0.4000
3-0	10.404	0.4096	9.4488	0.3720
2-0	9.266	0.3648	8.8392	0.3480
0	8.252	0.3249	8.2296	0.3240
1	7.348	0.2893	7.6200	0.3000
2	6.543	0.2576	7.0104	0.2760
3	5.827	0.2294	6.4008	0.2520
4	5.189	0.2043	5.8928	0.2320
5	4.620	0.1819	5.3848	0.2120
6	4.115	0.1620	4.8768	0.1920
7	3.665	0.1443	4.4704	0.1760
8	3.264	0.1285	4.0640	0.1600
9	2.906	0.1144	3.6576	0.1440
10	2.588	0.1019	3.251	0.1280
11	2.305	0.09074	2.946	0.1160
12	2.053	0.08081	2.642	0.1040
13	1.828	0.07196	2.337	0.0920
14	1.628	0.06408	2.032	0.0800
15	1.450	0.05707	1.829	0.0720
16	1.291	0.05082	1.626	0.0640
17	1.150	0.04526	1.422	0.0560
18	1.024	0.04030	1.219	0.0480
19	0.912	0.03589	1.016	0.0400
20	0.812	0.03196	0.914	0.0360
21	0.723	0.02846	0.813	0.0320
22	0.644	0.02535	0.711	0.0280
23	0.573	0.02257	0.610	0.0240
24	0.511	0.02010	0.559	0.0220
25	0.455	0.01790	0.508	0.0200
26	0.405	0.01594	0.457	0.0180
27	0.361	0.01420	0.417	0.0164
28	0.321	0.01264	0.376	0.0148

GAUGE NO.	AWG OR B&S		SWG	
	MM	IN	MM	IN
29	0.286	0.01126	0.345	0.0136
30	0.255	0.01003	0.315	0.0124
31	0.227	0.008928	0.295	0.0116
32	0.202	0.007950	0.274	0.0108
33	0.180	0.007080	0.254	0.0100
34	0.160	0.006305	0.234	0.00920
35	0.143	0.005615	0.213	0.00840
36	0.127	0.005000	0.193	0.00760
37	0.113	0.004453	0.173	0.00680
38	0.101	0.003965	0.152	0.00600
39	0.0897	0.003531	0.132	0.00520
40	0.0799	0.003145	0.122	0.00480
41	0.0711	0.002800	0.112	0.00440
42	0.0633	0.002494	0.102	0.00400
43	0.0564	0.002221	0.0914	0.00360
44	0.0502	0.001978	0.0813	0.00320
45	0.0447	0.001761	0.0711	0.00280
46	0.0398	0.001568	0.0610	0.00240
47	0.0355	0.001397	0.0508	0.00200
48	0.0316	0.001244	0.0406	0.00160
49	0.0281	0.001108	0.0305	0.00120
50	0.0250	0.000986	0.0254	0.00100
51	0.0203	0.000800	0.0223	0.000878
52	0.0152	0.000600	0.0199	0.000782
53	0.0127	0.000500	0.0177	0.000697
54	0.0102	0.000400	0.0157	0.000620
55	0.0076	0.000300	0.0140	0.000552
56			0.0125	0.000492
57			0.0111	0.000438
58			0.00991	0.000390
59			0.00881	0.000347
60			0.00785	0.000309

TEMPERATURE CONVERSION TABLE

The numbers in the middle column indicates the temperature as read. The corresponding temperature in Fahrenheit is given on the right and those in Celsius on the left.

Example: If 10 degrees are read in Celsius, look in the right column and convert it to 50°F. If 10 degrees F is read, look in the left column and convert it to -12.2°C.

°C		°F	°C		°F	°C		°F
-17.8	0	32	-1.11	30	86.0	15.6	60	140.0
-17.2	1	33.8	-0.56	31	87.8	16.1	61	141.8
-16.7	2	35.6	0	32	89.6	16.7	62	143.6
-16.1	3	37.4	0.56	33	91.4	17.2	63	145.4
-15.6	4	39.2	1.11	34	93.2	17.8	64	147.2
-15.0	5	41.0	1.67	35	95.0	18.3	65	149.0
-14.4	6	42.8	2.22	36	96.8	18.9	66	150.8
-13.9	7	44.6	2.78	37	98.6	19.4	67	152.6
-13.3	8	46.4	3.33	38	100.4	20.0	68	154.4
-12.8	9	48.2	3.89	39	102.2	21.1	70	158.0
-12.2	10	50.0	4.44	40	104.0	21.7	71	159.8
-11.7	11	51.8	5.00	41	105.8	22.2	72	161.6
-11.1	12	53.6	5.56	42	107.6	22.8	73	163.4
-10.6	13	55.4	6.11	43	109.4	23.3	74	165.2
-10.0	14	57.2	6.67	44	111.2	23.9	75	167.0
-9.44	15	59.0	7.22	45	113.0	24.4	76	168.8
-8.89	16	60.8	7.78	46	114.8	25.0	77	170.6
-8.33	17	62.6	8.33	47	116.6	25.6	78	172.4
-7.78	18	64.4	8.89	48	118.4	26.1	79	174.2
-7.22	19	66.2	9.44	49	120.2	26.7	80	176.0
-6.67	20	68.0	10.0	50	122.0	27.2	81	177.8
-6.11	21	69.8	10.6	51	123.8	27.8	82	179.6
-5.56	22	71.6	11.1	52	125.6	28.3	83	181.4
-5.00	23	73.4	11.7	53	127.4	28.9	84	183.2
-4.44	24	75.2	12.2	54	129.2	29.4	85	185.0
-3.89	25	77.0	12.8	55	131.0	30.0	86	186.8
-3.33	26	78.8	13.3	56	132.8	30.6	87	188.6
-2.78	27	80.6	13.9	57	134.6	31.1	88	190.4
-2.22	28	82.4	14.4	58	136.4	31.7	89	192.2
-1.67	29	84.2	15.0	59	138.2	32.2	90	194.0

(cont.)

TEMPERATURE CONVERSION TABLE

(cont.)

°C		°F	°C		°F	°C		°F
32.8	91	195.8	221	430	806	468	870	1598
33.3	92	197.6	227	440	824	471	880	1816
33.9	93	199.4	232	450	842	477	890	1634
34.4	94	201.2	238	460	860	482	900	1652
35.0	95	203.0	243	470	878	488	910	1670
35.6	96	204.8	254	490	914	493	920	1688
36.1	97	206.6	260	500	932	499	930	1706
36.7	98	208.4	266	510	950	504	940	1724
37.2	99	210.2	271	520	968	510	950	1742
38	100	212	277	530	986	516	960	1760
43	110	230	282	540	1004	521	970	1778
49	120	248	288	550	1022	527	980	1796
54	130	266	293	560	1040	532	990	1814
60	140	284	299	570	1058	538	1000	1832
66	150	302	304	580	1076	543	1010	1850
71	160	320	310	590	1094	549	1020	1868
77	170	338	316	600	1112	554	1030	1886
82	180	356	321	610	1130	560	1040	1904
88	190	374	327	620	1148	566	1050	1922
93	200	392	332	630	1166	571	1060	1940
99	210	410	338	640	1184	577	1070	1958
100	212	413	343	650	1202	582	1080	1976
104	220	428	349	660	1220	588	1090	1994
110	230	446	354	670	1238	593	1100	2012
116	240	464	360	680	1256	599	1110	2030
121	250	482	366	690	1274	604	1120	2048
127	260	500	371	700	1292	610	1130	2066
132	270	518	377	710	1310	616	1140	2084
138	280	536	382	720	1328	621	1150	2102
143	290	554	388	730	1346	627	1160	2120
149	300	572	393	740	1364	632	1170	2138
154	310	590	399	750	1382	643	1190	2174
160	320	608	404	760	1400	649	1200	2192
166	330	626	410	770	1418	654	1210	2210
171	340	644	416	780	1436	660	1220	2228
177	350	662	421	790	1454	666	1230	2246
182	360	680	427	800	1472	671	1240	2264
188	370	698	432	810	1490	677	1250	2282
193	380	716	438	820	1508	682	1260	2300
199	390	734	443	830	1526	688	1270	2318
204	400	752	449	840	1544	693	1280	2336
210	410	770	454	850	1562	699	1290	2354
216	420	788	460	860	1580	704	1300	2372

(cont.)

°C		°F	°C		°F	°C		°F
710	1310	2390	949	1740	3164	1193	2180	3956
716	1320	2408	954	1750	3182	1199	2190	3974
721	1330	2426	960	1760	3200	1204	2200	3992
727	1340	2444	966	1770	3218	1210	2210	4010
732	1350	2462	971	1780	3236	1216	2220	4028
738	1360	2480	977	1790	3254	1221	2230	4046
743	1370	2498	982	1800	3272	1227	2240	4064
749	1380	2516	988	1810	3290	1232	2250	4082
754	1390	2534	993	1820	3308	1238	2260	4100
760	1400	2552	999	1830	3326	1243	2270	4118
766	1410	2570	1004	1840	3344	1249	2280	4138
771	1420	2588	1010	1850	3362	1254	2290	4154
777	1430	2606	1016	1860	3380	1260	2300	4172
782	1440	2624	1021	1870	3398			
788	1450	2842	1032	1890	3434			
793	1460	2660	1038	1900	3452			
799	1470	2678	1043	1910	3470			
804	1480	2696	1049	1920	3488			
810	1490	2714	1054	1930	3506			
816	1500	2732	1060	1940	3524			
821	1510	2750	1066	1950	3542			
827	1520	2768	1071	1960	3560			
832	1530	2786	1077	1970	3578			
838	1540	2804	1082	1980	3596			
843	1550	2822	1088	1990	3614			
849	1560	2840	1093	2000	3632			
854	1570	2858	1099	2010	3650			
860	1580	2876	1104	2020	3668			
866	1590	2894	1110	2030	3686			
871	1600	2912	1116	2040	3704			
877	1610	2930	1121	2050	3722			
882	1820	2948	1127	2060	3740			
888	1630	2966	1132	2070	3758			
893	1640	2984	1138	2080	3776			
899	1650	3002	1143	2090	3794			
904	1660	3020	1149	2100	3812			
910	1670	3038	1154	2110	3830			
916	1680	3058	1160	2120	3848			
921	1690	3074	1166	2130	3866			
927	1700	3092	1171	2140	3884			
932	1710	3110	1177	2150	3902			
938	1720	3128	1182	2160	3920			
943	1730	3146	1188	2170	3938			

TEMPERATURE CONVERSION TABLE

(cont.)

°C		°F
1266	2310	4190
1271	2320	4208
1277	2330	4226
1282	2340	4244
1288	2350	4262
1293	2360	4280
1299	2370	4298
1304	2380	4316
1310	2390	4334
1316	2400	4352
1321	2410	4370
1327	2420	4388
1332	2430	4406
1338	2440	4424
1343	2450	4442
1349	2460	4460
1354	2470	4478
1360	2480	4496
1366	2490	4514
1371	2500	4532
1377	2510	4550
1382	2520	4568
1388	2530	4586
1393	2540	4604
1399	2550	4622
1404	2560	4640
1410	2570	4658
1421	2590	4694
1427	2600	4712
1432	2610	4730
1438	2620	4748
1443	2630	4766
1449	2640	4784
1454	2650	4802
1460	2660	4820
1466	2670	4838
1471	2680	4856
1477	2690	4874
1482	2700	4892
1488	2710	4910
1493	2720	4928
1499	2730	4946
1504	2740	4964

°C		°F
1510	2750	4982
1516	2760	5000
1521	2770	5018
1527	2780	5036
1532	2790	5054
1538	2800	5072
1543	2810	5090
1549	2820	5108
1554	2830	5126
1560	2840	5144
1566	2850	5162
1571	2860	5180
1577	2870	5198
1582	2880	5216
1588	2890	5234
1593	2900	5252
1599	2910	5270
1604	2920	5288
1610	2930	5306
1616	2940	5324
1621	2950	5342
1627	2960	5360
1632	2970	5376
1638	2980	5396
1643	2990	5414
1649	3000	5432
1654	3010	5450
1660	3020	5468
1666	3030	5486
1671	3040	5504
1677	3050	5522
1682	3060	5540
1688	3070	5558

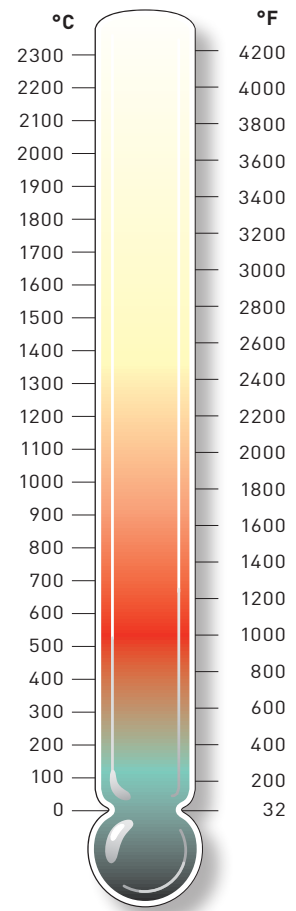

INTERPOLATION TABLE

°C		°F
0.56	1	1.8
1.11	2	3.6
1.67	3	5.4
2.22	4	7.2
2.78	5	9.0
3.33	6	10.8
3.89	7	12.6
4.44	8	14.4
5.00	9	16.2
5.56	10	18.0

MISCELLANEOUS CONVERSION FACTORS

TO CONVERT FROM	TO	MULTIPLY BY
Btu	kilo-calorie	0.25200
Btu	foot-pound	778.17
Btu	joules	1054.0
Btu	kilowatt-hour	0.00029307
calorie	joule	4.1840
Centigrade	Fahrenheit	$(1.8 \times ^\circ\text{C}) + 32$
circular mil	square centimeter	0.000005067
circular mil	square inch	0.0000007854
circular mil	square mil	0.78540
cubic centimeter	cubic inch	0.061024
dyne	gram	0.0010197
dyne	newton	0.00001
dyne	pound	0.0000022481
Fahrenheit	Centigrade	$0.555 \times (^\circ\text{F} - 32)$
gallon (US) (liquid)	liter	3.7854
gallon (UK) (liquid)	liter	4.54
gallon	pint (liquid)	8
gallon	quart (liquid)	4
gram	ounces (US) (fluid)	0.035274
gram	ounce (troy)	0.032151
gram	pound	0.0022046
gram/centimeter	pound/inch	0.0055997
gram/cubic centimeter	ounce/gallon	133.5
gram/cubic centimeter	pound/cubic foot	62.428
horsepower	kilowatt	0.7457
inch	centimeter	2.54
inch	mil	1000
joule	newtonmeter	1
joule	kilo-calorie	0.00023866
kilogram	carat	5000
kilogram	pound	2.2046
kilogram	pounds (troy)	2.6792
kilogram	tons(short)	0.0011023
kilogram	ton (long)	0.00098421
kilo-calorie	kilo-newtonmeter	4.1868
kilo-newtonmeter	kilowatt-hour	0.00027
kilowatt	Btu/minute	56.878
kilowatt-hour	Btu	3413

(cont.)

MISCELLANEOUS CONVERSION FACTORS

(cont.)

TO CONVERT FROM	TO	MULTIPLY BY
kilowatt-hour	kilo-calorie	860
kilowatt-hour	joule	3600000
liter	cubic inch	61.023
liter/minute	gallon/second	0.0044029
meter	inch	39.370
meter	yard	1.0936
microinch	micrometer	25.4
microinch	millimeter	0.0254
micrometer	inch	0.000039370
mile	foot	5280
millimeter	mil	39.370
newton	pound-force	0.22481
ohm-circular mil/foot	ohm-square mil/foot	1.273
ohm-circular mil/foot	ohm-square millimeter/meter	0.00166
ohm-circular mil/foot	microhm centimeter	0.16624
ounce	pound	0.0625
ounces (US) (fluid)	cubic inch	1.8047
ounces (US) (fluid)	liter	0.02957
ounce (troy)	gram	31.10
ounce (troy)	grain	480
ounce (troy)	pounds (troy)	0.083333
pound	gram	453.59
pound	grain	7000
pound	kilogram	0.45359
pounds (troy)	grain	5760
pounds (troy)	gram	373.24
pounds (troy)	pound	0.82286
square centimeter	square inch	0.15500
square foot	square meter	0.092903
square inch	square centimeter	6.45
square meter	square foot	10.76
square millimeter	circular mil	1973.5
square mil	circular mil	1.2732
square mil	square centimeter	0.0000064516
square mil	square inch	0.000001
stone	pound	14
watt	foot-pound/minute	44.254
watt	kilo-calorie/minute	0.014331

Sandvik Group

The Sandvik Group is a global high technology enterprise with 47,000 employees in 130 countries. Sandvik's operations are concentrated on five business areas in which the group holds leading global positions in selected niches: Sandvik Mining, Sandvik Machining Solutions, Sandvik Materials Technology, Sandvik Construction and Sandvik Venture.

Sandvik Materials Technology

Sandvik Materials Technology is a world-leading developer and manufacturer of products in advanced stainless steels and special alloys for the most demanding environments, as well as products and systems for industrial heating.

Kanthal is a Sandvik owned brand, under which world class heating technology products and solutions are offered. Sandvik, Kanthal, Nifethal, Nikrothal, Alkrothal and Cuprothal are trademarks owned by Sandvik Intellectual Property AB.

Quality management

Sandvik Materials Technology has quality management systems approved by internationally recognized organizations. We hold, for example, the ASME Quality Systems Certificate as a materials organization, approval to ISO 9001, ISO/TS 16949, ISO 17025 and PED 97/23/EC. We also have product and/or shop approvals from bodies such as TÜV, JIS, DNV and Lloyd's Register.

Environment, health and safety

Environmental awareness, health and safety are integral parts of our business and are at the forefront of all activities within our operation. We hold ISO 14001 and OHSAS 18001 approvals.

Recommendations are for guidance only, and the suitability of a material for a specific application can be confirmed only when we know the actual service conditions. Continuous development may necessitate changes in technical data without notice.

This printed matter is only valid for Sandvik material. Other material, covering the same international specifications, does not necessarily comply with the mechanical and corrosion properties presented in this printed matter.

